



### Product features:

- Swivel showerhead connector for maximum flexibility
- Rub clean anti limescale spray nozzles
- Single spray pattern showerhead
- Metal & ABS construction
- The perfect combination of European design styles

### Packaged properties:

**Box length:** 225 mm      **Box depth:** 143 mm  
**Box width:** 143 mm      **Boxed weight:** 0.36 kg

**Includes pop up waste?:** No

**Additional comments:**

### Product dimensions:

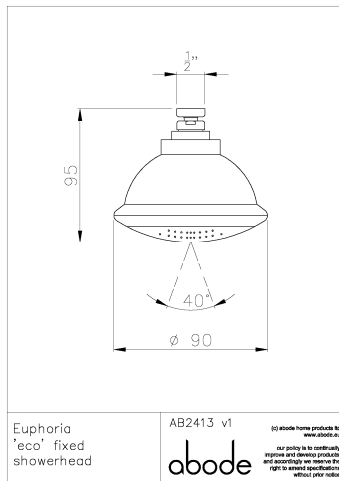

- Overall Height / projection: 95 mm
- Exit reach:
- Exit height: 95 mm
- Centre distance(s):
- Base diameter(s):
- Product mounted where: Roof / wall
- Recommended hole diameter:
- Min. fitting depth required:
- Max. surface depth:

### Product flow characteristics:

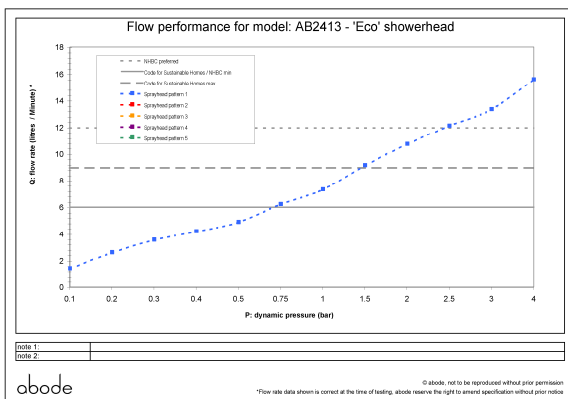

- Min / Max water pressure: 0.75 / 5 bar
- Part G mixed flow rate at 3 bar (l/m): 13.36

- Max water temperature: 70° C
- Product flow characteristics:
- Aerator type:
- Includes output diverter?: No
- Control valve type: ( )
- Non return valve position:
- Mesh particle filter size: 0.60 mm
- Inlet / outlet size: 1/2" F /
- Inlet type / length: / mm
- Shower hose type / length:

### Warranty Summary (Full details available on request):

- Materials and workmanship defects warranted for 5 years
- Valves and working parts warranted for 5 years
- Surface warranty defects warranted for 1 year
- O-rings, hoses & gaskets warranted for 1 year

### Care instructions:

- Clean the mixers and showers regularly as required, using soap, do not use any other cleaners.
- Regular cleaning will prevent the build up of lime scale and dirt
- After cleaning rinse thoroughly with clean water to remove any cleaner residue
- Residues of liquid soaps, shampoos and shower foams can also cause damage, so rinse with clean water after using, avoid contact with any abrasives