

Bidbury & Co

Traditional Kitchen Tap Collection

Taynton

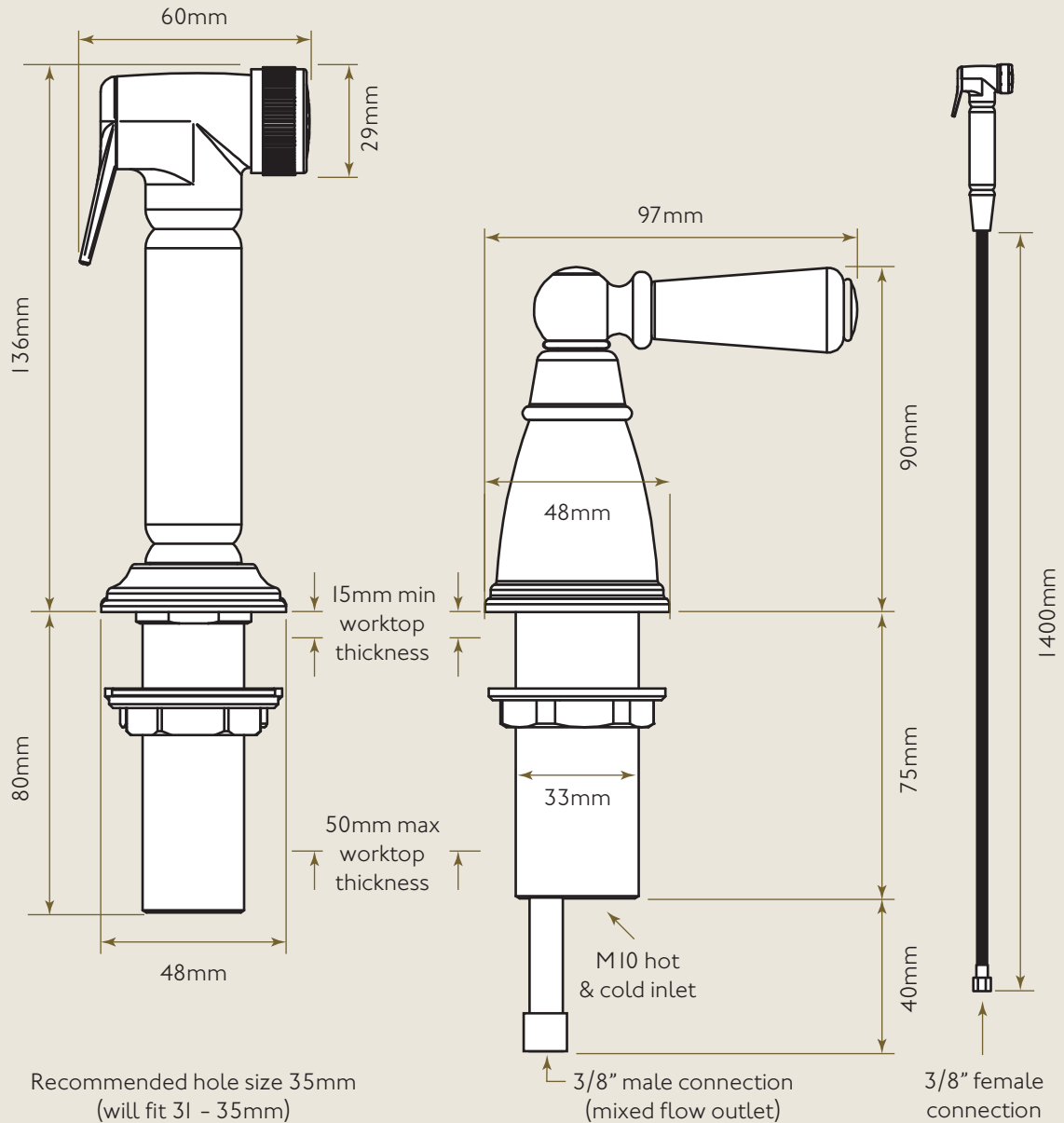

RECOMMENDED HOLE SIZE 35mm

ENSURE CORRECT PRESSURE BEFORE FITTING:
Minimum operating pressure 0.5 Bar
Recommended operating pressure 1.0 Bar
Maximum operating pressure 3.0 Bar

INDEPENDENT SPRAY WITH LEVER HANDLE