

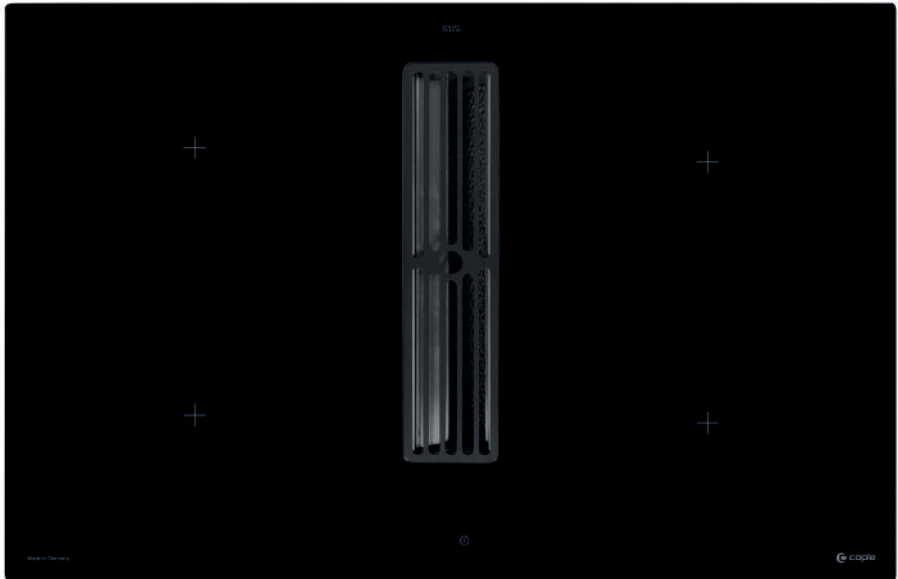

# Induction Downdraft Extractor Instruction Manual

---

# DD820BK



Contact Caple on 0117 938 7420 for spare parts or [www.caple.co.uk](http://www.caple.co.uk)

## CONTENTS

---

Introduction	3
Safety Instructions	4
Appliance Description	13
Operating the Hob	14
Operating the Downdraft	34
Care and Maintenance	38
Troubleshooting	41
Installation	45
After Sales	58
Caple Contact Details	60

# INTRODUCTION

Thank you for choosing this Caple induction downdraft extractor.

To ensure that you get the best results from your new induction downdraft extractor, we strongly suggest that you read this instruction manual thoroughly before use. If treated with care, your Caple product should give you years of trouble-free use.

To register ownership, please ensure you complete and return the guarantee card supplied with the appliance or visit [www.caple.co.uk](http://www.caple.co.uk) and register here.

This instruction manual is designed to provide you with all the required information related to the installation, use and maintenance of the appliance.

This induction downdraft extractor is designed to extract unpleasant odours and cooking vapours from the kitchen. In order to operate the unit correctly and safely, please read this instruction manual carefully before installation and use.

Please read this manual carefully before using your appliance. It contains important safety advice; it explains how to use and look after your appliance so that it will provide you with many years of reliable service.

Should a fault arise, please first consult the "Troubleshooting" section. You can often rectify minor problems yourself, thus saving unnecessary service costs.

Please keep this manual in a safe place and pass it on to new owners for their information and safety.

## INSTALLATION WARNINGS

- When the appliance is unpacked, make sure that it has not been damaged during transportation.
- In the case of a defect do not use the appliance and contact a qualified service agent immediately. The materials used for packaging (nylon, staplers, Styrofoam, etc.) may be harmful to children and they should be collected and removed immediately.
- The appliance must be installed by an authorised technician. The manufacturer is not responsible for any damage that might be caused by defective placement and installation by unauthorised people.
- Installation and repair work that is carried out by unauthorised technicians may be dangerous. Do not alter or modify the specifications of the appliance in any way.
- Do not operate the appliance before it is fully installed.
- Before connecting your appliance, make sure that the local distribution conditions (nature of the gas and gas pressure or electricity voltage and frequency) and the specifications of the appliance are compatible.
- The specifications for this appliance are stated on the rating label.
- Protect your appliance against atmospheric effects.
- Do not expose it to effects such as sun, rain, snow, dust or excessive humidity.
- Materials around the appliance (i.e. cabinets) must be able

to withstand a minimum temperature of 100°C.

- The temperature of the bottom surface of the hob may rise during operation, therefore it is recommended a board is installed underneath the product.
- The extracted air must not be discharged into a flue that is used for exhausting fumes from appliances burning gas or other fuels.
- Regulations concerning the discharge of air have to be conformed to.
- Make sure that the supply cord is not trapped or damaged during installation. If the supply cord is damaged, it must be replaced by the manufacturer, its service agent or similarly qualified persons in order to prevent a hazard.

## GENERAL SAFETY WARNINGS

- This appliance can be used by children aged from 8 years and above and by persons with reduced physical, sensory or mental capabilities or lack of experience and knowledge if they have been given supervision or instruction concerning use of the appliance in a safe way and understand the hazards involved. Children should not play with the appliance. Cleaning and user maintenance should not be made by children without supervision.
- Your appliance is produced in accordance with all applicable local and international standards and regulations.
- The performance of your extractor will vary depending on a number of factors. These include type of extraction, room volume, length of ducting, ventilation available and the cleanliness of the filters.

## DURING USE:

- To ensure the best performance, we recommend switching on the extractor 15 minutes before cooking and leave it running 15 minutes after. This will ensure that the air in the kitchen is being circulated before cooking commences and the air is being cleaned after cooking has finished.
- Do not put flammable or combustible materials on or near the appliance when it is operating.

- Do not leave the hob unattended while cooking with solid or liquid oils. They may catch fire under extreme heating conditions. Never pour water on to flames that are caused by oil, instead switch the hob off and cover the pan with its lid or a fire blanket.
- If the product will not be used for a long period of time, turn the main control switch off.
- Always position pans over the centre of the cooking zone, and turn the handles to a safe position so they cannot be knocked or grabbed.
- Do not operate the appliance without a grease filter.
- When the induction hob is in use, keep objects that are sensitive to magnetic fields (such as credit cards, bank cards, watches, and similar items) away from the hob. It is strongly suggested that anyone with a pacemaker should consult their cardiologist before using the induction hob.
- Persons with cardiac pacemakers or implanted insulin pumps must make sure that their implants are not affected by the induction hob (the frequency range of the induction hob is 20-50 kHz).
- The appliance and its accessible parts become hot during use. Care should be taken to avoid touching heating elements. Keep children less than 8 years of age away unless they are continually supervised.

- Unattended cooking on a hob with fat or oil can be dangerous and may result in fire. NEVER try to extinguish such a fire with water, but switch off the appliance and cover the flame with a lid or a fire blanket.
- The cooking process has to be supervised. A short-term cooking process has to be supervised continuously.
- Constant supervision is essential when deep-frying; flambéing is not permitted.
- Danger of fire: Do not store items on the cooking surfaces.
- If the surface is cracked, switch off the appliance to avoid the possibility of electric shock.
- For induction hobs, metallic objects such as knives, forks, spoons and lids should not be placed on the hob surface because they can get hot.
- Metal items worn on your body may become hot in the immediate vicinity of the induction hob. Caution: Risk of burns. Non-magnetisable objects (e.g. gold or silver rings) are not affected.
- For induction hobs, after use switch off the hob element using the touch controls. Do not rely on the pan detector.
- Only hob protective grids and hob covers produced or recommended by the hob manufacturer or recommended may be used. The use of unsuitable hob protective grids and hob covers may result in accidents.
- Inappropriate hob guards can cause accidents.



- All possible measures have been taken to ensure your safety. Since the glass may break, care should be taken while cleaning to avoid scratching. Avoid hitting or knocking the glass with accessories.
- Please keep children and animals away from this appliance.
- Never use the cooking zones to heat up unopened tins of food or packaging made of material compounds.
- Do not place empty pots and pans on the cooking zones which have been switched on.
- Never put anything (pans, tea towels etc.) onto the control panel.
- Make sure there are no items (e.g. cleaning cloths) right next to the hob extractor. They could be sucked in by the air current. Liquids and small items must always be kept away from the appliance.
- Vapour also emits moisture into the air in the kitchen during the cooking process.
- Only a little moisture is removed from the vapours in the convection air mode. This is why a sufficient supply of fresh air must always be provided, e.g. by opening the window or using a domestic ventilation system.
- Hot pans should not cover the sensor keys, since this will cause the appliance to switch off automatically.

## CLEANING AND MAINTENANCE WARNINGS

- Maintenance and repair work should only be carried out by authorised service technicians.
- Make sure that your appliance is turned off at the mains before carrying out any cleaning or maintenance operations.
- To maintain the efficiency and safety of your appliance, we recommend you always use original spare parts and to call our authorised service agents in case of need.
- The extractor and its filter should be cleaned regularly in order to keep in good working condition.
- Clean the extractor according to the instruction manual to reduce the risk of fire.
- Do not use steam cleaners for cleaning the appliance.
- Do not use harsh abrasive cleaners or scourers to clean the hob surface.
- Keep the sensor keys clean since the appliance may consider dirt to be finger contact.

## APPROPRIATE USE:

- This appliance is intended to be used in household and similar applications such as:
  - › Staff kitchen areas in shops, offices and other working environments.
  - › Farm Houses.
  - › By clients in hotels, motels and other residential type environments.
  - › Bed and breakfast type environments.

## EXPLANATION FOR SYMBOLS AND INDICATIONS

This appliance was produced according to state of the art technology. Machines nevertheless give rise to risks which cannot be constructively avoided.

In order to guarantee sufficient safety for use, safety instructions are also given. These instructions are marked by way of the highlighted texts which follow.

Sufficient safety in operation will only be guaranteed when these instructions are observed.

The designated text passages have different meanings:



### NOTE

Note to be observed in order to make handling the appliance easier.



### WARNING OF ELECTRICAL ENERGY RISK OF FATAL INJURY

Live components have been installed near this symbol. Covers bearing this sign may only be removed by a certified skilled electrician.



## ENVIRONMENTAL PROTECTION

Waste electrical products should not be disposed of with household waste. Please recycle where facilities exist. Check with your Local Authority or retailer for recycling advice. This appliance is marked according to the European directive on Waste Electrical and Electronic Equipment (WEEE).

By ensuring this product is disposed of correctly, you will help prevent potential negative consequences for the environment and human health, which could otherwise be caused by inappropriate waste handling of this product. The symbol on the product indicates that this product may not be treated as household waste. Instead it shall be handed over to the applicable collection point for the recycling of electrical and electronic equipment. Disposal must be carried out in accordance with local environmental regulations for waste disposal.

For more detailed information about treatment, recovery and recycling of this product, please contact your local council, your household waste disposal service or the retailer where you purchased the product.

## WARRANTY

Your new appliance is covered by warranty. The warranty card is enclosed - if it is missing, you must provide the following information to your retailer in order to receive a replacement: date of purchase, model and serial number. Registration can also be completed online by visiting [www.caple.co.uk](http://www.caple.co.uk).

Ensure you keep your warranty card safe, you may need to show it to Caple Service together with proof of purchase. If you fail to show your warranty card you will incur all repair charges.

Spare parts are only available from Caple Service and spare parts authorised centres.

## CE DECLARATIONS OF CONFORMITY



This appliance has been manufactured to the strictest standards and complies with all applicable legislation, Low Voltage Directive (LVD) and Electromagnetic Compatibility (EMC).

## UKCA DECLARATIONS OF CONFORMITY



This appliance has been manufactured to the strictest standards and complies with all applicable legislation.

## TECHNICAL FICHE

This appliance conforms to all current and applicable energy regulations. To view the Technical Fiche that supports the energy labelling data, please visit the product page on our website [www.caple.co.uk](http://www.caple.co.uk).

## APPLIANCE DESCRIPTION

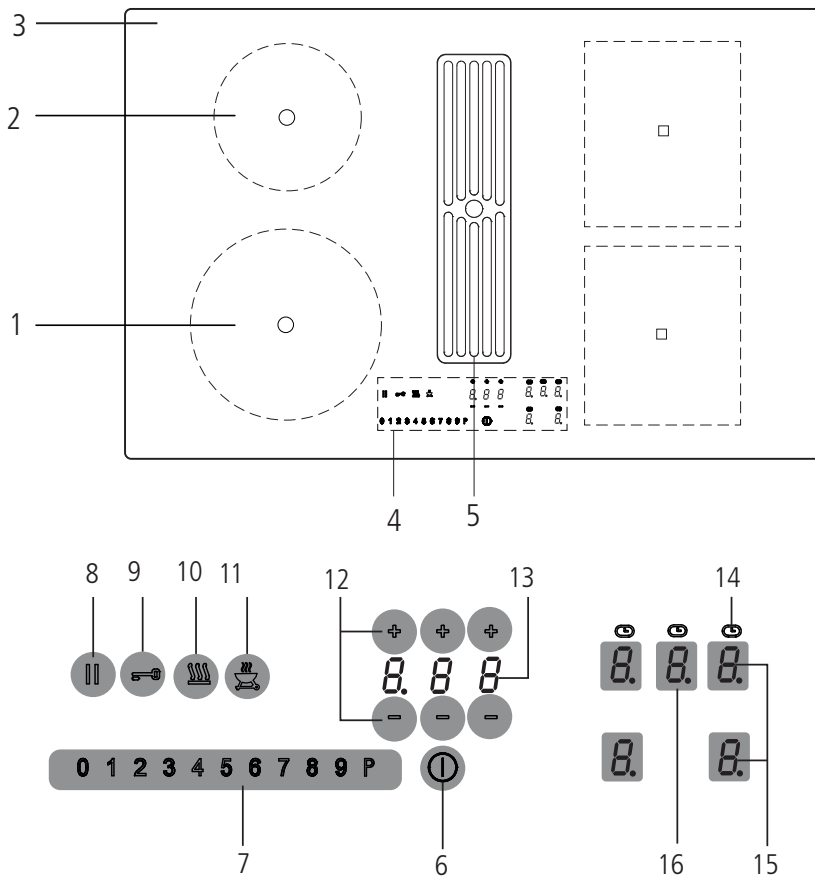

- |                                 |                                 |
|---------------------------------|---------------------------------|
| 1. Front induction cooking zone | 9. Lock key                     |
| 2. Rear induction cooking zone  | 10. Keep Warm Key               |
| 3. Glass ceramic hob            | 11. Grill key                   |
| 4. Touch-Control panel          | 12. Minus key /Plus key - timer |
| 5. Fan                          | 13. Timer indication            |
| 6. ON / OFF key (hob)           | 14. Display cooking zone timer  |
| 7. Power level control          | 15. Power setting display       |
| 8. Stop key (pause)             | 16. Fan Indication              |



### NOTE:

Most of the keys shown will only become visible when the hob has been switched on.

## OPERATING THE HOB

---

The hob is operated with touch control sensor keys. The sensor keys are operated as follows: Lightly touch a symbol on the surface of the ceramic glass plate. A buzzer will indicate when the controls have been operated correctly.

The touch control sensor key will then be indicated as "key".

### PERMANENT PAN RECOGNITION

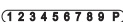
A cooking setting can only be switched on via the slider (touch control)  after a pan has been detected on the hob and the power display shows 0.

### ON/OFF KEY: (6) COOKING ZONES LEFT OR RIGHT

This key is used to switch the left or right hob on and off.

### POWER BOOST IN THE TOUCH CONTROL: (7)

The power boost setting makes additional power available for induction cooking zones.

### STOP/PAUSE KEY: (8)

The STOP/PAUSE function can be used to briefly stop the cooking process.

### RECALL FUNCTION: (8)

(Recovery function)

The most recent setting can be recovered if the hob is switched off unintentionally.

### CHILD SAFETY LOCK KEY: (9)

The lock key can be used to lock all of the keys.

### KEEP WARM KEY: (10)

To keep warm.

### GRILL KEY: (11)

Grill function with a griddle plate for induction.

### MINUS /PLUS KEY: (12)









These keys are used to set the timer and the automatic switch-off function of the cooking zones as well as the automatic delay stop of the fan.

## SYMBOLS (14)

 Timer function, automatic switch-off device.



## POWER SETTING DISPLAY: (15)

The power setting display shows the power setting which has been selected, or:

-  Residual heat
-  Power boost function
-  Pan recognition
-  Automatic boost function
-  Stop/Pause function
-  Child Safety Lock
-  Bridging function
-  Grill function
-  Keep-warm function

## FAN INDICATOR (16)

The power setting indicator shows the power setting which has been selected, or;

-  Automatic function
-  Replace the carbon filter

## THE SLIDER (TOUCH CONTROL)

In principle, the slider functions the same as the touch controls; the only difference is that you can put your finger on the glass ceramic surface and then move it around. The touch control recognises this movement and raises or lowers the display setting (power level) in accordance with the movement. The term touch control is used to mean slider from now on.

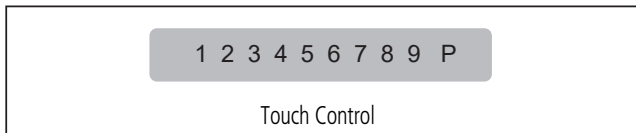

## WHAT MUST BE OBSERVED WHEN OPERATING TOUCH CONTROLS?

Your finger should not be placed flat onto the glass ceramic surface in order to avoid adjacent keys/touch controls from reacting by mistake.

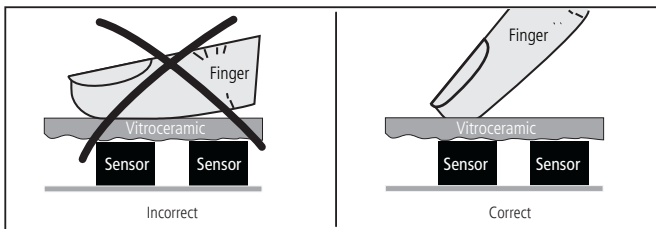

## PRESS THE TOUCH CONTROL LIGHTLY

### OR MOVE YOUR FINGER AROUND

You can press the touch control very lightly with your finger; when this is done the setting on the display (power level) will gradually change. Move to the right to Increase the power level.

When you put your finger on the touch control and then move it to the left or right, the display setting will change progressively. The faster the movement, the faster the change in the display.

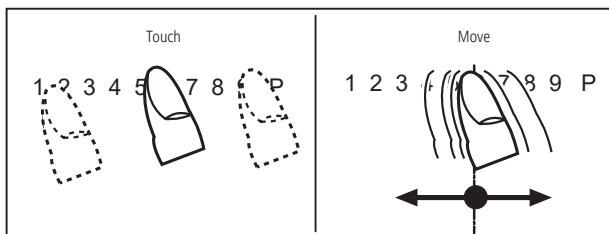

## NOTE:

Pressing a sensor key and keeping it pressed (for approx. 3 seconds) may activate the automatic boost function **R**. See the section on Automatic boost function.



## THE HOB

The hob is equipped with an induction cooking mode. An induction coil underneath the glass ceramic hob generates an electromagnetic alternating field which penetrates the glass ceramic and induces the heat-generating current in the pan base. With an induction cooking zone the heat is no longer transferred from a heating element through the pan into the food being cooked; instead the necessary heat is generated directly in the container by means of induction currents.

### ADVANTAGES OF THE INDUCTION HOB:

- › Energy-saving cooking through the direct transfer of energy to the pan (suitable pots/pans made of magnetisable material are required).
- › Increased safety as the energy is only transferred when a pan is placed on the hob.
- › Highly effective energy transfer between an induction cooking zone and the base of a pan.
- › Rapid heat-up.
- › The risk of burns is low as the cooking area is only heated through the pan base; food which boils over does not stick to the surface.
- › Rapid, sensitive control of the energy supply.

### PAN RECOGNITION:

If a cooking zone is switched on and there is no pan on the zone or if the pan is too small, there will be no transmission of power. A blinking  in the cooking level display points this out.

If a suitable pot or pan is placed on the cooking zone, the power setting will switch on and the power setting display will light up. The power supply will be cut off when the pan is removed and the power setting display will indicate a blinking .

If a pot or pan placed on a cooking zone is smaller than the cooking zone and the pan recognition still switches on, only the amount of power needed will be supplied. The permanent pan recognition recognises on which cooking zone a pan is set up and shows a 0 in the corresponding power setting display.

COOKING ZONE DIMENSION (MM)	RECOMMENDED PAN BASE MINIMUM DIAMETER (MM)
160	90
200	110
210 x 190	110

The base of pots and pans must be of a certain diameter; if it is not, the induction heat will not be switched on.

Always place pots and pans in the middle of a cooking zone in order to achieve the best efficiency.

**IMPORTANT:**

The minimum diameter required to activate the pan recognition device may vary according to the type of pot or pan used.

**OPERATION TIME LIMIT:**

The induction hob has an automatic time limit function.

The duration of continuous use of each cooking zone depends on the cooking level selected (see chart).

This requires that the setting of a respective cooking zone is not adjusted during use.

If the operation time limit has been activated, the cooking zone will switch off, a short signal will sound and an H will appear in the display.

The automatic switch-off function overrules the operation time limit, i.e. the cooking zone is only switched off when the period of time of the automatic switch-off device has expired (e.g. automatic switch-off after 99 minutes and cooking level 9 is possible).

SELECTED COOKING LEVEL	OPERATION TIME LIMIT IN MINUTES
<b>U</b>	120
1	516
2	402
3	318
4	258
5	210
6	138
7	138
8	108
9	90
P	10

## **OTHER FUNCTIONS:**

If two or more sensor keys are pressed at the same time (e.g. when a pan is mistakenly put onto a sensor key) no function will be activated.

The 'symbol Er03' will blink and a time-limited continuous signal will sound. After a few seconds the appliance will switch off. Please remove the item located in front of the sensor keys. To delete the 'symbol Er03' press the same key or switch the hob off and on.

## **PROTECTION AGAINST OVERHEATING (INDUCTION):**

If the hob is used at full power for a longer period, it will not be possible to cool down the electronics system as required at a high room temperature.

In order to ensure that no excessive temperatures occur in the electronics system, the power of the cooking zones may be reduced automatically.

Should E2 be displayed frequently during normal use of the hob and at normal room temperature, it is likely that cooling is not sufficient.

This may occur if kitchen units have no openings. The installation may have to be checked.

## **COOKWARE FOR INDUCTION HOB:**

Cookware for induction cooking zones must be made of metal and have magnetic properties. The base must be sufficiently large.

Only use pans with a base suitable for induction.

<b>SUITABLE COOKWARE</b>	<b>UNSUITABLE COOKWARE</b>
Enamelled steel pans with a thick base.	Pans made of copper, stainless steel, aluminium, oven-proof glass, wood, ceramic and terracotta.
Cast iron pans with an enamelled base.	
Pans made of multi-layer stainless steel, stainless ferrite steel and aluminium with special base.	

## HOW TO ESTABLISH THE SUITABILITY OF A POT:

Conduct the magnet test described below or make sure that the pot bears the symbol for suitability for cooking with induction current.

### MAGNET TEST:

When purchasing new pans, check the packing to confirm they can be used with induction hobs. Alternatively, the suitability of pans can be checked with a small magnet, if it sticks, it is likely to be compatible. You will also need to take into account other factors such as the pan size and shape.



### NOTE:

When using pans suitable for induction from certain manufacturers, noises may occur which are attributable to the design of these pans.

### UNSUITABLE COOKWARE:

The base of the pan is curved.

The electronic unit cannot determine the temperature correctly.

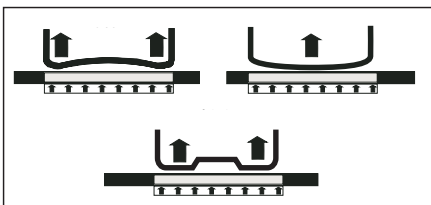

### SUITABLE COOKWARE:

The base of the pan must be flat and smooth.



See the 'Induction Hob Cookware' help-sheet on the appliance web page for further information.

### **ENERGY SAVING TIPS:**

The following are a few useful hints to help you cut your consumption of energy and use your new induction hob and the cookware efficiently.

- › The base of your cooking pans should be the same size as the cooking zone.
- › When buying cooking pans, note that it is frequently the diameter of the top of the pan that is indicated. This is usually larger than the base of a pan.
- › Pressure cookers are particularly low on energy and time cooking required, thanks to the pressure and the fact that they are tightly closed. Short cooking times mean that vitamins are preserved.
- › Always make sure that there is sufficient fluid in your pressure cooker since the cooking zone and the cooker may be damaged as a result of overheating if the pressure cooker boils dry.
- › Always close cooking pots with a suitable lid.
- › Use the right sized pan for the quantity of food you are cooking. A large pan which is hardly filled will use up a lot of energy.

## POWER SETTINGS

The heating power of the cooking zones can be set at various power levels. In the chart you will find examples of how to use each setting.

SETTING	SUITABLE FOR
0	Off, using remaining heat
<b>U</b>	Keep-warm function
1-2	Simmering small portions
3	Simmering level
4-5	Simmering larger quantities or roasting larger pieces of meat until they are cooked through
6	Roasting, getting juices
7-8	Roasting
9	Bringing to the boil, browning, roasting
P	Power boost (highest power output)



A higher power level may need to be selected for cooking pots without a lid.

## OPERATING THE KEYS:

A cooking setting can only be switched on via the touch control after a pan has been detected on the hob and the power display shows 0.

The following controls (described below) require the press of a key to be followed by the press of a subsequent key. The next key will need to be pressed within 10 seconds, otherwise the selection will be deleted.

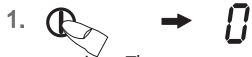
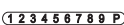
## SWITCHING ON THE HOB AND COOKING ZONES :

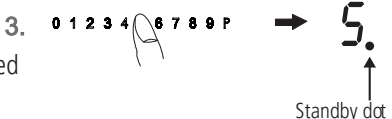
1. Press the **ON/OFF** key  (approx. 1 sec) until the power setting shows 0. A short signal will sound meaning the controls are ready for operation. The pan recognition recognises which cooking zone has a pan set up and shows 0 in the corresponding power display. 
2. The touch control  must be activated immediately afterwards. A power setting will turn on. 
3. Use the power setting display (as a key) to select a cooking zone. The standby dot of the selected cooking zone will light up.   
Standby dot

	Left	Power setting 1
	Centre	Power setting 5
	Right	Power setting P*

Move your finger over the touch control to select a power setting or to switch on an additional cooking zone.

## IMPORTANT:

The standby dot of the selected cooking zone must light up.

4. Immediately place suitable cookware on the cooking zone. The pan recognition device will activate the induction coil and the pot will heat up. If no pot is placed on the cooking zone, the display will alternate between the power level set and the  symbol. If no pot is placed on the cook zone it will switch off after 10 minutes.



Suitable for induction cooking

\*The power boost function is activated immediately. See 'Power Boost' section for further information.

## SWITCHING OFF A COOKING ZONE :

5. Use the power setting display (as a key) to select a cooking zone. The standby dot of the selected cooking zone must light up.

A) Press the sensor field on the far left or

B) Drag your finger to the left across the touch control to reduce the power setting 0.

## SWITCHING OFF THE HOB:

Press the ON/OFF key. The hob will switch off, irrespective of any settings.

### NOTE:

The hob will switch off automatically after 10 seconds when all the cooking zones are switched off manually (power setting 0) and no key/sensor is pressed afterwards.

## RESIDUAL HEAT DISPLAY: **H**

The glass ceramic hob is equipped with a **H** as a residual heat display.

As long as the H lights up after the cooking zone has been switched off, the residual heat can be used for melting food or for keeping food warm.

The cooking zone may still be hot when the letter **H** no longer lights up. There is a risk of burns.

The glass ceramic is not directly heated in the case of an induction cooking zone; it is only heated up by heat reflected by the pan.

## STOP/PAUSE FUNCTION: **||**

The cooking process can be briefly interrupted with the **STOP/PAUSE** function, e.g. if the doorbell rings. The **STOP/PAUSE** function must be released in order to continue cooking at the same power level. If a timer has been set it will pause and will then continue.

This function is only available for 10 minutes for reasons of safety. The hob will then be switched off.

1. Pots and pans are on the cooking zones and the required power levels have been set.
2. Press the **STOP/PAUSE** key **||** instead of the selected power settings, the interval sign **||** will light up.





3. The interruption is ended by firstly pressing the **STOP/PAUSE** key **||** and then any other key (except **ON/OFF** key) The second key must be pressed within 10 seconds as otherwise the stop function remains.

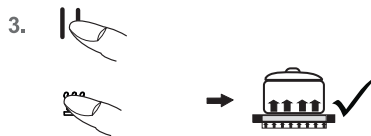

## RECALL FUNCTION: **||**

After inadvertently switching the hob off the last setting can be restored. The Recall function only works if at least one cooking zone is switched on.

1. The hob is inadvertently turned off by the **ON/OFF** key hob **Ⓛ**.

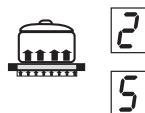

Within 6 seconds after turning it off, press the **ON/OFF** key hob **Ⓛ** again. The LED on the **STOP/PAUSE** button flashes.

2. Then immediately press the **STOP/PAUSE** key **||**. The original cooking levels are restored. The cooking process is continued.



6 sec.

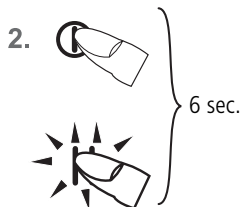

## WHAT CAN BE RESTORED:

- › Cooking levels of all cooking zones
- › Minutes and seconds of programmed timer functions
- › Automatic boost function
- › Power level





## WHAT CANNOT BE RESTORED:

- › Operation time limit (it is counted from 0)



## CHILD LOCK

The childproof lock is to prevent children from accidentally or intentionally turning on the induction hob. The controls are locked.

### ACTIVATING THE CHILD LOCK:

1. Press the **ON/OFF** key hob  (approx. 1 sec) until the power setting shows 0. 
2. Immediately afterwards press the setting display and keep it pressed (for approx. 3 seconds) until the touch control lights up from 0-P.  approx. 3 seconds.
3. Subsequently slide over the complete touch control from 0-P to activate the child safety lock. The controls will be disabled and the hob will switch off. 

### SWITCHING OFF THE CHILD LOCK:

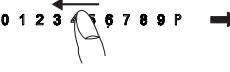
4. Press the **ON/OFF** key  
5. Immediately afterwards press the power setting display and keep it pressed (for approx. 3 seconds) until the touch control lights up from 0-P.  approx. 3 seconds.
6. Subsequently slide over the complete touch control from 0-P to deactivate the child safety lock. The L will turn off. 

### NOTE:

In case of a power cut the child lock will be cancelled, i.e. deactivated.

## BRIDGING FUNCTION:

The front and the rear cooking zones may be activated together for a cooking process (bridging function). This enables larger cookware to be used.

1. Switch on the hob.
2. Press the two cooking zone selection keys of the front and back cooking zones simultaneously to activate the bridging function. The bridging function has been switched on and the back power level setting shows the bridge . Operation is carried out with the front power level setting and the touch control.
3. Activate the front and back cooking zones simultaneously again or switch the hob off to deactivate the two power level settings (as a key).

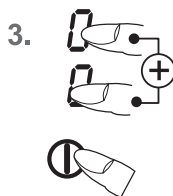
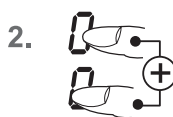
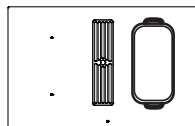

### NOTE:









The pan will need to cover at least half of the cooking zones used in order to be recognised by the pan recognition device.

### NOTE:

Bridge function only available on right hand side of hob.

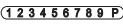
## GRILL FUNCTION:

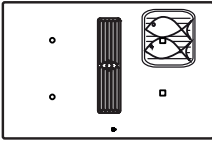
Use the grill function with the recommended griddle plate for induction.



1. Switch on the hob. 
2. Use the front power setting display (as a key) to select a cooking zone. The stand-by dot of the selected cooking zone will light up. 
3. Press the Grill key  to activate the grill function. The front and back cooking zones are activated together.  → 
4. The touch control  must be activated immediately afterwards. A power setting will be switched on.  → 
5. Put the griddle plate onto the cooking zone and then the food to be grilled. 
  - Level 1-3 for vegetables
  - Level 4-6 for fish
  - Level 7-9 for meat
6. To switch off the grill function press the Grill key  or switch off the hob. 

### NOTE:

Never operate the appliance unattended.

## AUTOMATIC SWITCH-OFF (TIMER):

The automatic switch-off device is used to automatically switch off any cooking zone after an adjustable period of time. Cooking times ranging from 0.10 to 9.59 (hour:minutes) can be set.

1. Switch on the hob. Switch on one or more cooking zones and select the required power settings. 
2. Switch on one or more cooking zones and select the required power settings. 
3. Use the power setting display (as a key) to select a cooking zone. The standby dot of the cooking zone selected will light up. Select the timer display and use the Plus key **+** or the Minus key **-** of the timer to set the required time.



**Left position:** Hours

**Centre position:** Every 10 minutes

**Right position:** Every minute



After a few seconds the entry will be taken over and the time will be running. The timer symbol  of the cooking zone lights up.

4. The cooking zone will be switched off when the time has lapsed. A signal will sound for a while and can be switched off by pressing any key (except the **ON/OFF** key ). 

### NOTE:

- › Repeat steps 2 to 4 to programme the automatic switch-off device for another cooking zone.
- › To check the time that has lapsed (automatic switch-off) press the timer display (as a key). The setting displayed can be read and changed.
- › Terminating the function of the timer: Select the respective cooking zone and press the minus key **-** to delete the time (0).
- › If several cooking zones have been programmed with the automatic switch-off function, the timer display will always show the cooking zone with the shortest time.

## MINUTE MINDER (EGG TIMER)

1. Switch on the hob
2. Press the Plus **+** and Minus key **-** to set the required time.
3. Once the time has lapsed a signal will sound for a while and can be switched off by pressing any key (except the **ON/OFF** key **ⓘ**).



### NOTE:

The minute minder remains in operation when the left or right hob is switched off. Switch the left or right hob on to adjust the time.

The minute minder will switch off after approx. 120 min. when the **ON/OFF** key **ⓘ** is used for switching off.

## AUTOMATIC BOOST FUNCTION:

When the automatic boost function is selected, food is part-boiled at power setting 9. After a certain time the power level will switch down automatically to a lower simmering setting (1 to 8).

When using the automatic boost function only the power setting with which the food is to be cooked through needs to be selected since the electronic unit switches down automatically.

The automatic boost function is suitable for dishes which are cold initially and are then heated up at high power. These dishes do not need to be constantly monitored when cooking (e.g. boiling meat for soups).

SELECTED POWER LEVEL	AUTOMATIC BOOST FUNCTION TIME (MIN:SEC)
1	00:48
2	02:24
3	03:50
4	05:12
5	06:48
6	02:00
7	02:48
8	03:36
9	-

1. Switch on the hob.
2. Press the touch control and keep it pressed (for approx. 3 seconds) to activate the function and immediately select a specific power setting:



The symbol **H** will light up. This will activate the automatic boost function. **A** and the selected simmering setting will blink alternately.

3. **S** The automatic boost function will operate as programmed. After a certain time (see chart) the cooking process will be continued with the power setting. The **A** symbol will go off.

### NOTE:

The power setting can be raised while the automatic boost function is in operation. A reduction in the power setting will switch off the automatic boost function.

## KEEP WARM FUNCTION:



With this function you can use one of the cooking zones to keep food warm (70°C), help with baking or control the boiling. The respective cooking zone is operated at a low power level.

1. Cookware is placed on a cooking zone and a power level (e.g. 3) is selected.



2. By pressing the Warming key  select the Keep Warm function.

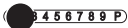

3. To switch off the function, press the touch control  on the far left or press the Warming key .



The keep-warm function is available for 120 minutes, after which the cooking zone will be switched off.

## LOCKING:

The lock can be used to lock key operation and cooking level settings. Only the **ON/OFF** key can be used to switch the hob off.

### ACTIVATING THE LOCK:

1. Press the Lock key .  
The lock key will light up brightly.  
The controls are locked.



### SWITCHING OFF THE LOCK:

2. Press the Lock key  to deactivate the function. The lock key will light up with a dimmed light.



### NOTE:

- › An activated lock will remain activated even if the hob is switched off. It must therefore be de-activated when cooking is re-commenced.
- › In the event of a power cut the lock will be cancelled, i.e. deactivated.



## POWER BOOST **P**

The power boost setting makes additional power available for induction cooking zones. A large quantity of water can be brought to the boil very quickly.

1. Switch on the hob. Use the power setting display (as a key) to select a cooking zone. The stand-by dot of the cooking zone selected will light up.
2. Press the touch control **0 1 2 3 4 5 6 7 8 9 P** on the far right. The power boost setting will be activated.
3. After 10 minutes the power boost setting will switch off automatically. The **P** will go off and the power level will switch down to 9.

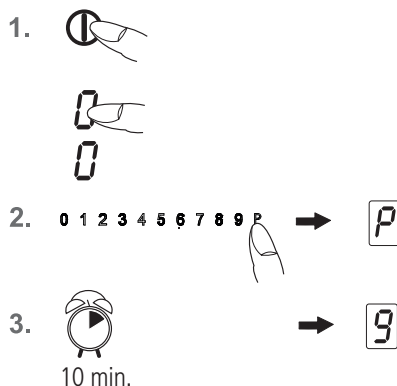

### NOTE:

Press the respective touch control to prematurely switch off the power boost setting.

### POWER MANAGEMENT:

For technical reasons two cooking zones always comprise a module and have a maximum power level.

If this power range is exceeded when a higher power setting level or the power boost function is switched on the power management system will reduce the power setting of the corresponding cooking zone of the module. The display for this cooking zone will initially blink, after which the highest possible power setting will be consistently displayed.

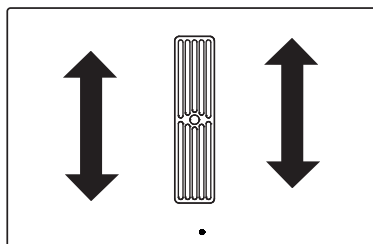

Modules (power management)

## OPERATING THE DOWNDRAFT:

The fan is located in the middle of the hob with the extractor facing downwards.

The black grill cover does not have to be removed.

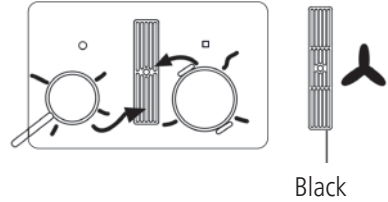



### IMPORTANT:

Do not put the cover onto the induction hob. Risk of burning.

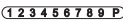
### SWITCHING THE FAN ON AND OFF:

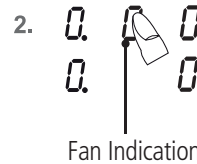
1. Press the **ON/OFF** key  (approx. 1 sec.) until the fan power setting '0' appears and a short signal will sound. The controls are ready for operation.
2. Use the power setting display (as a key) to select a cooking zone. The standby dot will light up.
3. The touch control  must be activated immediately afterwards. A power setting will be switched on.

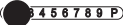

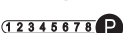
Left		Power Setting 0
Centre		Power Setting 5
Right		Power Setting P

To change the fan level, select the fan display and then press the touch control.

### IMPORTANT:

The standby dot of the cooking zone selected must light up.

### AUTOMATIC FUNCTION:

1. To select Automatic mode, press and hold the fan display (as a key) until 'A' for automatic mode is shown in the display. The standby dot will light up.
2. Then select one or more cooking zones and set a power level.
3. The fan level is now automatically controlled according to the set power levels.

The automatic mode operates slightly delayed and gradually according to the set power levels.

You can switch back to manual mode at any time by holding down the fan display or selecting the fan display and pressing the touch control.

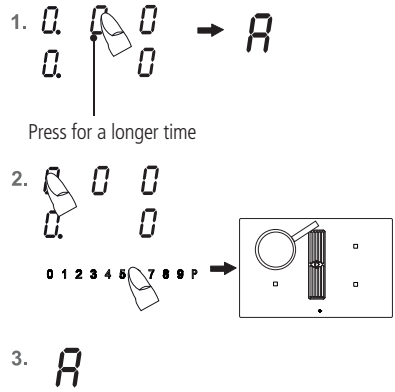

## FAN TIMER:

The fan timer is used after cooking to completely eliminate cooking odours. In addition, the filters are dried in the fan timer.

### SETTING THE FAN TIMER:

1. Select the fan indication.
2. Then use the Plus key  $+$  or the Minus key  $-$  of the timer to set the required time for the fan time lag.  
**Left position:** Hours  
**Centre position:** Every 10 minutes  
**Right position:** Every minute
3. After a few seconds, your selection will be assumed and the procedure will have commenced. The timer symbol  of the fan lights up.
4. The fan will be switched off when the time has lapsed.



If a cooking zone is switched on, the timer does not run until the cooking zone has been switched off. If the hob is switched off using the **ON/OFF** key during fan after run-time, the timer runs down to a low fan level.

### **STOP DELAY TIME:**

The fan motor should continue operating for another 10-20 minutes every time the hob has been used for cooking. When the fan is switched off after having been in operation for at least 15 minutes, an automatic time lag at a low setting will follow for around 15 minutes.

This guarantees optimal functioning and the removal of remaining cooking steam. When using a recirculating air filter, please always allow for a stop delay time of 10 - 60 minutes in order to optimally remove cooking odours.

When the fan is switched on again, in rare cases the odour molecules present in the filter may be combined with steam so that they are detected again. These remaining odours will disappear when the fan continues to operate.

### **IMPORTANT:**

When the convection air mode is in operation, ventilation must be sufficient in order for the air humidity to be removed.

### **REPLACEMENT OF THE FILTER :**

If an existing carbon filter must be cleaned or replaced, this is indicated in the fan display by a .

When the fan is switched on, the display for a cooking process is deleted.

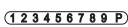
To reset the display, the fan display and the touch control  must be pressed simultaneously for approx. 3 seconds.

If no carbon filter is used, the display indication  must also be reset.

## CARE AND MAINTENANCE

---

- › Switch the hob off and let it cool down before you clean it.
- › Never clean the glass ceramic hob with a steam cleaner or similar appliance.
- › When cleaning make sure that you only wipe lightly over the ON/OFF KEY. The hob may otherwise be accidentally switched on.

### **GLASS CERAMIC HOB IMPORTANT NOTE:**

Never use aggressive cleaning agents such as rough scouring agent, abrasive saucepan cleaners, rust and stain removers etc.

### **CLEANING AFTER USE:**

- › Always clean the entire hob when it has become soiled. It is recommended that you do so every time the hob is used. Use a damp cloth and a little washing up liquid for cleaning. Then dry the hob with a clean dry cloth to ensure that there is no detergent left on the surface of the hob.

### **WEEKLY CLEANING:**

- › Clean the entire hob thoroughly once a week with commercial glass ceramic cleaning agents. Please follow the manufacturer's instructions carefully. When applied, the cleaning agent will coat the hob in a protective film which is resistant to water and dirt. All the dirt will remain on the film and can then easily be removed. Then rub the hob dry with a clean cloth. Make sure that no cleaning agent remains on the surface of the hob since this will react aggressively when the hob is heated up and will change the surface.

### **GREASE FILTER:**

After a period of time, the grease filters will start to become saturated in fat and grease. Because of this, these should be washed regularly (roughly once every 2 months). The grease filters can be washed by hand with warm soapy water or in the dishwasher. These filters need to be cleaned on a regular basis, because otherwise they may represent a fire risk.

To remove the filter, lift up the fan cover and lift the U-shaped stainless steel ventilation plate in the suction intake opening upwards to remove it from the fan. Now remove the filter. To do so, press the lock in the recessed handle downwards and remove the filter.

If washing in the dishwasher, stand the filter upright. Only use rinse aid that is suitable for use with aluminium in order to avoid damaging and discolouring the filters. Never rinse right next to glasses or light-coloured porcelain.

### **WARNING:**

Do not operate the fan without grease filters.

After rinsing the filter, dry it and replace it in the fan. Please make sure that the recessed handle is visible after you have replaced the filter. If possible, wipe the easily accessible inside of the fan with a cloth dampened with detergent every time you replace a filter, while at the same time paying attention to protruding parts in the inside of the fan.

#### **FAN CLEANING:**

The fan is best cleaned every time you clean the filters. Condensation water may collect under the filter after water has boiled rapidly with the lid of the pot removed. This is quite normal. The water should, however, be removed and the inside of the extraction housing cleaned. The ventilation openings in the cover ensure that residual moisture resulting from cooking and cleaning can escape if necessary, when the fan is not in operation and the cover is on. Clean the filter and the inside of the fan if unpleasant remaining odours escape. The fan is best cleaned with a soft damp cloth and mild soapy water.

#### **CHARCOAL FILTER:**

If recirculating your appliance, the Charcoal Filter Recirculation Kit (**CAP83CF**) can be purchased. The charcoal filter must be replaced at least every 6 months to ensure it remains effective. Replacement filter (**CAP84CF**) can be purchased from [www.caple.co.uk](http://www.caple.co.uk) or via our national sales office tel: **0117 938 1900**.

### **SPECIFIC SOILING:**

Heavy soiling and stains like limescale and shiny, mother-of-pearl type stains are best removed when the hob is still slightly warm. Use commercial cleaning agents to clean the hob. Proceed as outlined under Care and Maintenance.

First soak food which has boiled over with a wet cloth and then remove remaining soiling with a special glass scraper for glass ceramic hobs. Then clean the hob again as described under Care and Maintenance.

Burnt sugar and melted plastic must be removed immediately, when they are still hot with a glass scraper. Then clean the hob again as described under Care and Maintenance.

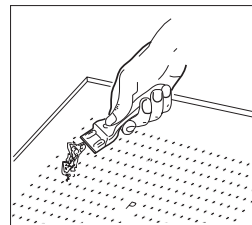

Grains of dirt which may get onto the hob when you peel potatoes or clean lettuce may scratch the surface of the hob when you move pots around. Make sure that no grains of dirt are left on the hob.

Changes in the colour of the hob will not affect the function and the stability of the glass ceramic material. These colour changes are not changes in the material but food residues which were not removed and which have burnt into the surface.

Shiny spots result when the base of the cookware rubs on the surface of the hob, particularly when cookware with an aluminium base or unsuitable cleaning agents are used. They are difficult to remove with standard cleaning agents. You may need to repeat the cleaning process several times. In time, the decoration will wear off and dark stains will appear as a result of using aggressive cleaning agents and faulty pan bases.



## TROUBLESHOOTING

---

Interference with and repairs to the appliance by unqualified persons are dangerous as they can result in an electric shock or a short circuit. Do not interfere with or try to repair the appliance; this could cause injury to persons and damage to the appliance. Always have such work done by a Caple approved engineer or similar qualified persons.

### **PLEASE NOTE:**

If your appliance is faulty, please check whether you can rectify the problem yourself by consulting these instructions for use.

You may be able to rectify some problems yourself. They are described below.

### **THE FUSES BLOW REGULARLY?**

Contact Caple Service or an electrician.

### **YOU CAN'T SWITCH YOUR INDUCTION HOB ON?**

- › Has the wiring system (fuse box) in the house blown a fuse?
- › Has the hob been connected to the mains?
- › Are the sensor keys locked (childproof lock)?
- › Are the sensor keys partly covered by a damp cloth, fluid or a metallic object? Please rectify.
- › Are you using unsuitable cookware? See the section on "Cookware for induction hobs"

### **THE SYMBOL WILL BLINK AND A TIME-LIMITED CONTINUOUS SIGNAL WILL SOUND.**

Food which has boiled over, cookware or other items are causing the touch control sensor keys to be consistently operated.

Clean the surface or remove the item.

To delete the  symbol, press the same key or switch the hob off and on.

**ERROR CODE E2 IS INDICATED?**

The electronic unit is too hot. Check the installation of the hob.

Make sure that there is sufficient ventilation.

See the section on "Protection against overheating".

See the section on "Ventilation".

**ERROR CODE E8 IS INDICATED?**

Fault on the left or right fan.

The suction opening is blocked or covered or the fan is defect.

Check the installation of the hob. Make sure that there is sufficient ventilation.

See the section on "Ventilation".

**ERROR CODE U400 IS INDICATED?**

The hob has been incorrectly connected. The controls will switch off after 1 second and a continuous signal will sound. Connect the appliance to the appropriate power supply.

**AN ERROR CODE (ERXX OR EX) IS INDICATED?**

The appliance has developed a technical defect. Please call Caple Service.

**THE POT SIGN U APPEARS?**

A cooking zone has been switched on and the hob is expecting a suitable pot or pan to be placed on the cooking zone (pan recognition). Only when a pot has been placed on the cooking zone will power be supplied.

**THE POT SIGN U STILL APPEARS, EVEN THOUGH A POT OR PAN WAS PLACED ON THE HOB?**

The cookware is unsuitable for induction cooking or the pot or pan is too small.

**IS THE COOKWARE YOU ARE USING MAKING NOISES?**

This is due to technical reasons and perfectly normal; the induction hob and the pan are not at risk.

**DOES THE COOLING FAN STILL OPERATE AFTER IT HAS BEEN SWITCHED OFF?**

This is normal since the electronic unit is being cooled down.

**IS THE HOB MAKING NOISES (CLICKING OR CRACKING SOUNDS)?**

This is for technical reasons and cannot be avoided.

**DOES THE HOB HAVE TEARS OR CRACKS?**

There is a risk of electric shocks if the glass ceramic hob develops fractures, cracks, tears or damage of any other kind. Immediately switch off the appliance. Disconnect the fuse immediately and call Customer Service.

## SAFETY INSTRUCTIONS FOR KITCHEN UNIT FITTERS:

- › Veneers, adhesives and plastic surfaces of surrounding furniture must be temperature resistant ( $>75^{\circ}\text{C}$ ). If the veneers and surfaces are not sufficiently heat resistant they may become deformed.
- › Ensure that all live connections are safely insulated when installing the hob.
- › Cover Strips between the wall and the worktop behind the hob which are made of solid wood are permissible as long as minimum clearances in accordance with the installation diagrams are maintained.
- › Minimum clearances of the hob cut-out towards the rear are to be maintained in accordance with the installation diagram.
- › For installation directly next to a tall cupboard, a safety distance of at least 50mm must be ensured. The side surface of the tall cupboard should be fitted with heat resistant material. Due to working requirements, however, the distance should be at least 300mm.
- › The packaging materials (plastic foil, polystyrene, nails etc.) must be kept out of reach of children as these parts are potentially dangerous. Small parts can be swallowed and there is a danger of plastic sheeting causing suffocation.

## VENTILATION:

- › The induction hob is fitted with a fan that switches on and off automatically. If the temperature produced by the electronic device exceeds a certain level, the fan turns on at a low speed. In case the induction hob is being used intensively, the fan switches to a higher speed. Once the electronics are cooled sufficiently, the fan reduces the speed and switches off automatically.
- › Clearance between the induction hob and kitchen furniture or built-in units must provide for sufficient ventilation of the induction hob.
- › If the power level of a cooking zone is automatically raised or lowered (see section on thermal cut-off device) it is likely that the cooling system does not cool sufficiently. In this case we recommend that the back wall of the bottom kitchen unit in the area of the worktop cut-out be opened and that the front transverse strip of the unit be removed over the entire width of the appliance in order to promote the circulation of air.

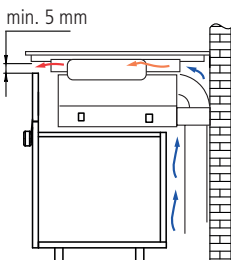

In order to better ventilate the hob, an air gap of 5mm should be left at the front.

## INSTALLATION

---

### **IMPORTANT INFORMATION:**

- › Remove any transverse strips underneath the worktop at least in the area of the worktop cut-out.
- › When installing the appliance on top of a drawer it is essential to ensure that no sharp items are stored in the drawer since these could become bent on the underside of the hob and prevent the drawer from being opened and closed.
- › If a shelf has been inserted underneath the hob, there must be a clearance of at least 20mm to the underside of the hob in order to ensure that the hob is sufficiently ventilated.
- › To avoid danger of fire, make sure that no combustible objects which could easily catch fire or become deformed on exposure to heat are directly next to or under the surface.

### **SEALING OF THE HOB**

Before installation, correctly insert the sealing unit delivered with the hob.

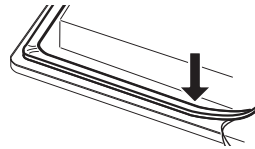

- › No liquids may penetrate between the edge of the hob and the worktop or between the hob and the wall and come into contact with any electrical appliances.
- › When installing a hob into an uneven worktop, e.g. with a ceramic or similar covering (tiles etc.), the seal on the hob is to be removed and the seal between the hob and worktop made with plastic sealing materials (putty).
- › The hob must under no circumstances be sealed with silicone sealant. This would make it impossible to remove the hob at a later date without damaging it.

## WORK SURFACE CUT-OUT:

Cut out the worktop recess accurately with a good, straight saw blade or recessing machine. The cut edges should then be sealed so that no moisture can penetrate.

The area is cut out as illustrated. The glass ceramic hob must have a level and flush bearing. Any distortion may lead to fracture of the glass panel. Make sure that the sealing of the hob is properly seated.

## INSET INSTALLATION:

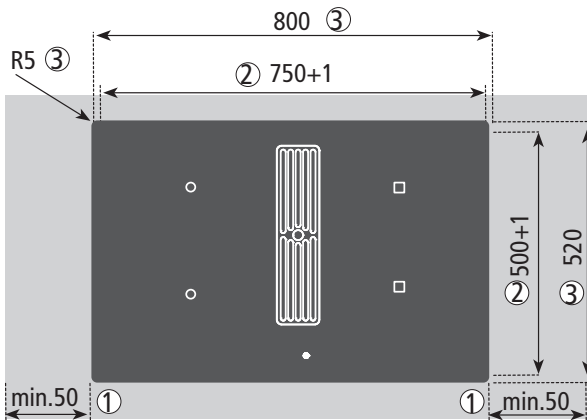

Insert the hob and align it.

- ① Minimum distance to adjacent walls
- ② Cutout dimensions
- ③ Outer dimensions of the hob

## IMPORTANT:

There is a risk of breakage if the hob is canted or subjected to stress during installation.

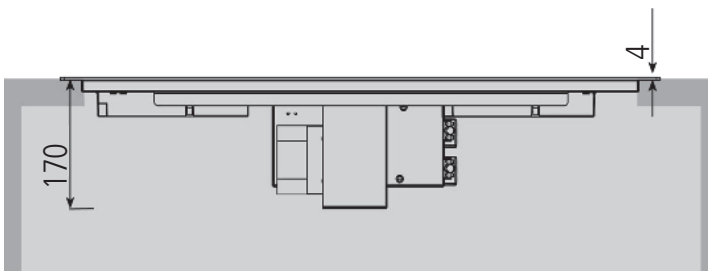

## FLUSH INSTALLATION:

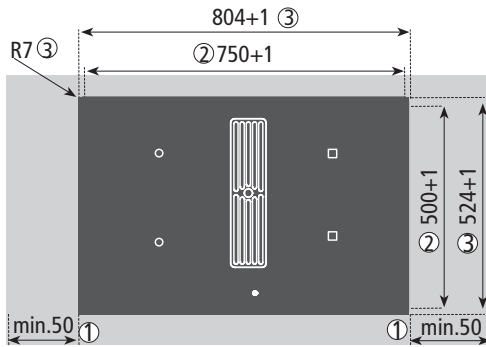

Glue the sealing tape onto the corner of the supporting edge of the worktop so that no silicone adhesive can be pressed under the hob.

Place the hob into the worktop cut-out without any adhesive and align it. Use shims if necessary.

Fill the gap between the hob and the worktop with heat-resistant silicone adhesive.

- ① Minimum distance to adjacent walls
- ② Cutout dimensions
- ③ Flush mount dimensions

## IMPORTANT:

Silicone adhesive must not get under the support surface. If this occurs it will not be possible to remove the hob again at a later stage. No liability will be assumed in the case of failure to observe these instructions.

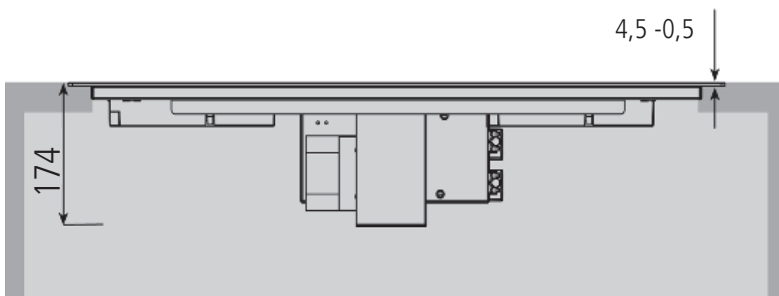

## DIMENSIONS

---

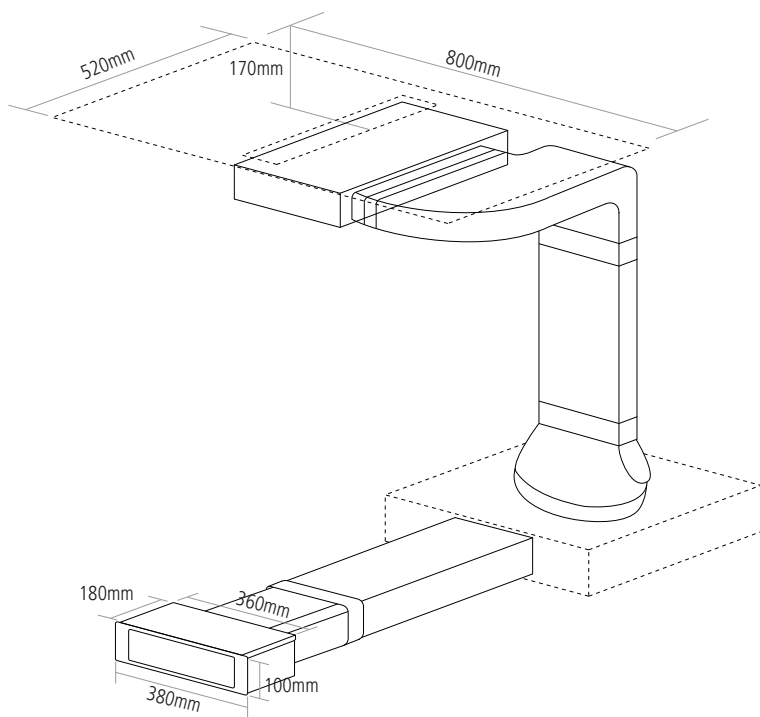

Inset cut-out 750 x 500mm. Refer to manual for further information.



## VENTED INSTALLATION:

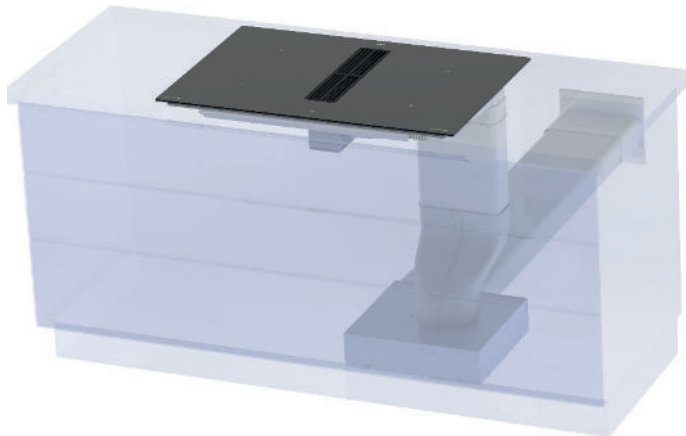

## RECIRCULATED INSTALLATION:

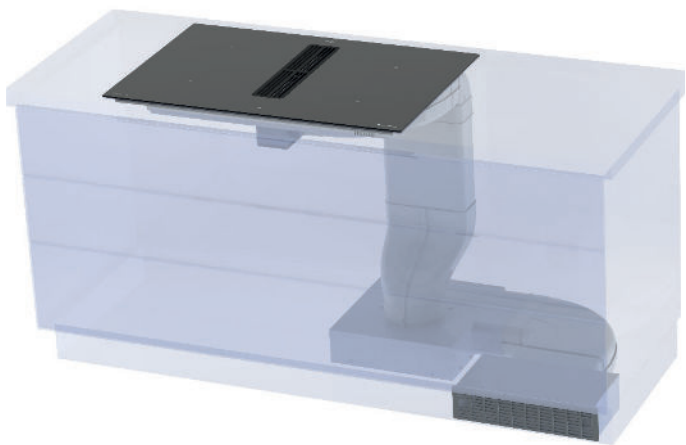

If recirculated, then recirculation Ducting Kit (**KIT/961W**) and Charcoal Recirculation Kit (**CAP83CF**) can be purchased. Replacement filter (**CAP84CF**) can be purchased from [www.caple.co.uk](http://www.caple.co.uk) or via our national sales office tel: **0117 938 1900**.

KIT/961W includes 2 x 90 degree vertical bends and 2 x 1 metre flat channels to allow you to connect the downdraft hob to your recirculation kit as shown in the image above.

### NOTE:

1 metre flat channels are to be cut to size, depending on the type of installation.

## SIDE VIEW OF RECIRCULATING INSTALLATION:

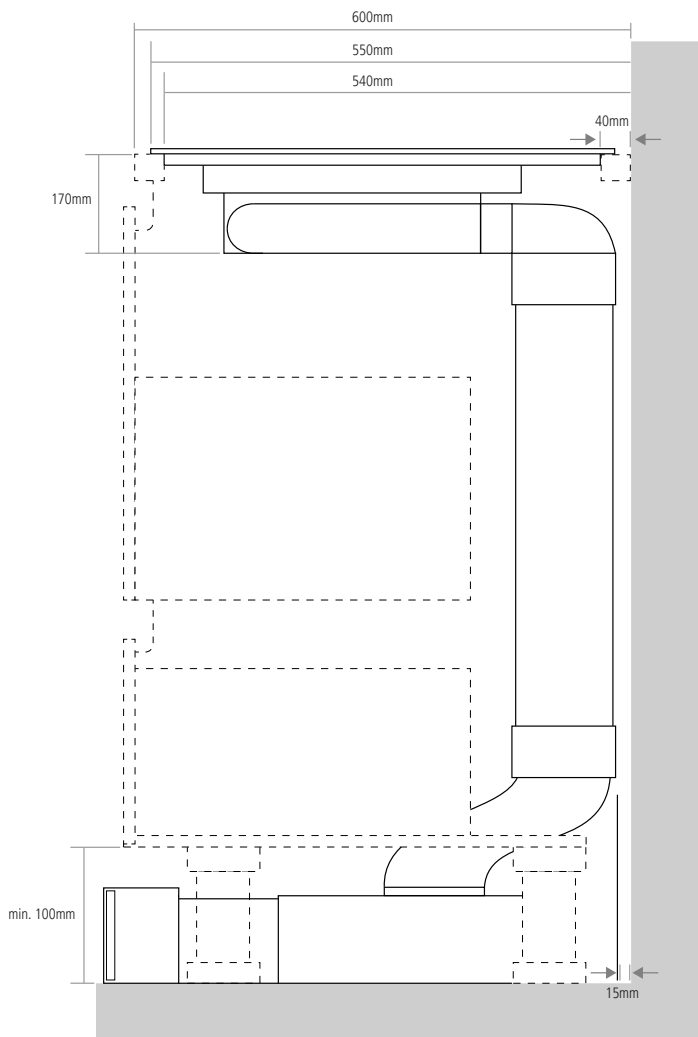

**REAR VIEW OF RECIRCULATING INSTALLATION:**

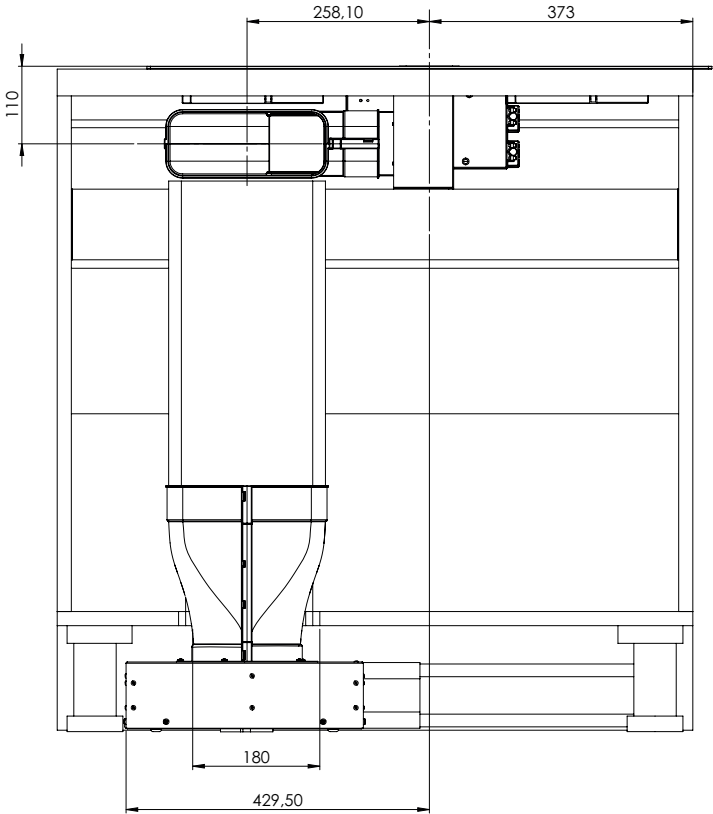

Rear view of 90cm cabinet

- › The product may only be connected by a qualified fitter according to applicable local regulations. The same applies for the extraction air connections. The fitter is responsible for proper functioning at the installation site.
- › On installation, observe the relevant national building regulations and the regulations of the electricity suppliers.
- › The hob fan can be operated in the extraction air and recirculation air mode.
- › Lead the extracted air outside through a ventilation shaft intended for this purpose or through the wall of the building.
- › Extracted air may not be led into a smoke or exhaust gas flue which is in operation.
- › A sufficient supply of inlet air must be provided if a wood, coal, gas or oil heater requiring a chimney is operated in the environment of the hob fan, since an insufficient supply of air results in a risk of poisoning. The safe operation of the hob extractor is guaranteed when the negative pressure resulting from the hob extractor does not exceed 0.04mbar (4 Pa) and a sufficient supply of inlet air can flow into the room.
- › Exhaust air pipes must comply with fire class B 1 DIN 4102.
- › Please make sure that the minimum nominal width of the appliance connecting pieces is not reduced.
- › A system recommended for the airflow and compatible with the hob extractor should always be used.
- › The nominal width of the recirculation air pipe should not be less than 150mm.
- › Exhaust air pipes should be as short as possible. They should not have a 90-degree angle; instead they should have soft bends and no reductions in their cross-section.
- › Never use pipes with a diameter of less than 150mm. No bends/angles may be laid 50cm before the fan module
- › Always insert a straight piece of approx. 50cm between two angles/bends.
- › The cross-section of wall vents and the cut-out in the base panel should at least correspond to the exhaust air pipe. The outflow opening must be at least 500cm<sup>2</sup>. Reduce the height of the skirting boards or make corresponding openings.
- › When installing the appliance make sure that the convection air unit is still accessible when the kitchen has been completely installed.
- › If necessary, levelling feet for the kitchen units must be moved.

**NOTE:**

When the convection air mode is in operation, ventilation must be sufficient in order for the air humidity to be removed.

## CONNECTION WINDOW CONTACT/RELAY CONNECTION



### WARNING OF ELECTRICAL ENERGY. RISK OF FATAL INJURY.

Live components have been installed near this symbol. Covers bearing this sign may only be removed by a certified skilled electrician.

#### ATTENTION:

- › The connection for the window contact switch and relay connection is under mains voltage.
- › Personal injury due to electric shock.
- › Disconnect the hob from the power supply before connecting the switching system.
- › The electrical connection must be carried out by a qualified electrician who is authorised to carry out such work.

### CONNECTION WINDOW CONTACT (A)

Voltage 16V DC; max. 2 W DC

Only approved window contact switches with potential-free contact may be connected to the contact loop. The contact must be closed when the window is open.

### RELAY CONNECTION (B)

Switching capacity max. 240V, 4A

Potential-free relay contact

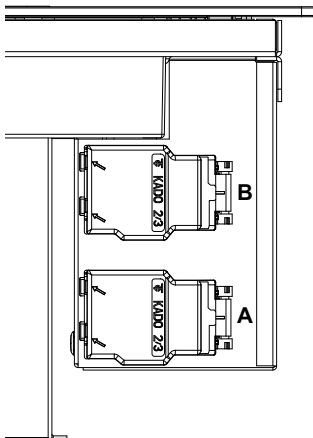

#### FRONT VIEW

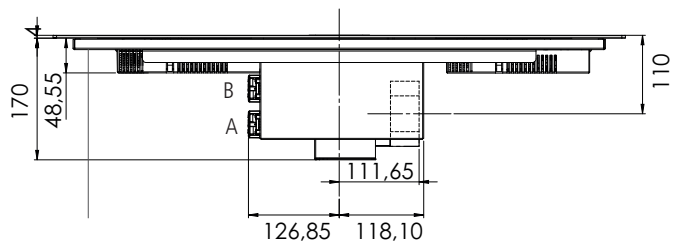

## ELECTRICAL CONNECTION



### **WARNING OF ELECTRICAL ENERGY. RISK OF FATAL INJURY.**

Live components have been installed near this symbol. Covers bearing this sign may only be removed by a certified, skilled electrician.

- › The electrical connection must be carried out by a qualified electrician who is authorised to carry out such work.
- › Statutory regulations and the connection specifications issued by the local power supply company must be strictly observed.
- › When connecting the appliance it must be ensured that there is a device which makes it possible to disconnect it from the mains at all poles with a contact opening width of at least 3mm. Line-protecting switches, fuses or contactors are suitable cut-out devices. When connecting and repairing the appliance, disconnect it from the electricity supply with one of these devices.
- › The earth wire must be sufficiently long so that if the strain relief fails, the live wires of the connecting cable are subjected to tension before the earth wire.
- › Any unnecessary cable must be removed from the installation area beneath the appliance.
- › Make sure that the local mains voltage is the same as the voltage on the rating label.
- › Full protection against accidental contact must be ensured on installation.

### **ATTENTION:**

Incorrect connection may result in the power electronics unit being destroyed.

Power supply -Mains voltage: 380-415V 2N~, 50/60Hz

Component rated voltage: 220-240V

Fuse rating: 32amp

### **UK INSTALLATION:**

Power supply - Mains voltage: 220-240V 1N~, 50/60Hz

Component rated voltage: 220-240V

Fuse rating: 32amp

## MAINS CABLE

- › The hob has been fitted with a temperature-resistant connection cable.
- › Connection to the mains is carried out in accordance with the circuit diagram, unless the connection cable is already fitted with a plug.
- › If the mains cable of this appliance is damaged it will need to be replaced with a special connection cable. In order to avoid any risks, this must be carried out by Caple Service or an approved engineer.

## ELECTRICAL CONNECTIONS

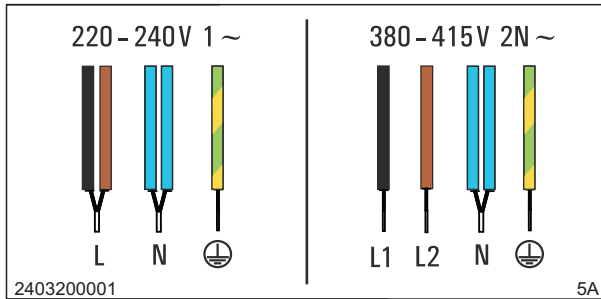

## TECHNICAL DATA

<b>Hob dimensions</b> [Height/Width/Depth]	174 x 800 x 520mm
<b>Cooking Zones</b> 1x Induction cooking zone Ø cm/kW	20/ 2,3/ 3,0*
1x Induction cooking zone Ø cm/kW	16/ 1,4/ 2,1*
2x Induction cooking zone Ø cm/kW	19 x 21/ 2,1/ 3,0*
Bridging Function... kW	3,7
<b>Fan</b> Max. air stream... m <sup>3</sup> /h	596
<b>Power Supply</b> Hob.. kW Fan... kW	7.2 0.168

\* Power when the power boost function is activated



## PUTTING THE APPLIANCE INTO OPERATION

Once the hob has been installed and the power supply has been provided (mains connected) an automatic test of the controls will be carried out and service information will be indicated.

### IMPORTANT:

No items may be on the touch control sensor keys when the appliance is being connected.

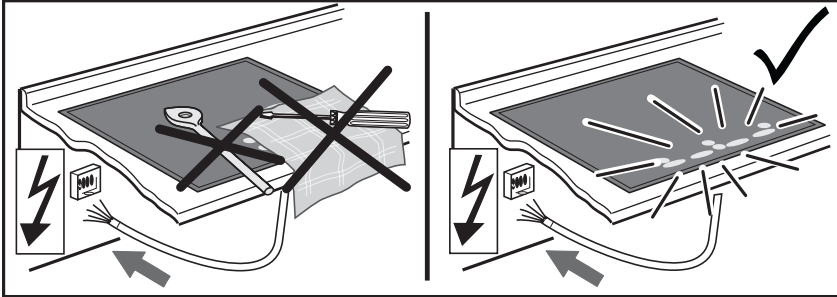

Briefly wipe over the surface of the hob with a sponge and soapy water and then dry with a clean cloth.

## AFTER SALES SERVICE

---

Any maintenance operation on your appliance should be carried out by:

- › Either your retailer;
- › Or another Caple approved engineer or similar qualified person.

If a problem still persists and further assistance is required, please contact our Caple after sales team on:

**T - 0117 938 7420**

**E - [service@caple.co.uk](mailto:service@caple.co.uk)**

**NOTES:**



Caple Service	BS11 8DW
Fourth Way	T: 0117 938 1900
Avonmouth	E: <a href="mailto:service@caple.co.uk">service@caple.co.uk</a>
Bristol	<a href="http://www.caple.co.uk">www.caple.co.uk</a>