



Dishwasher  
Instruction Manual

---

# DI654



Contact Caple on 0117 938 7420 for spare parts or [www.caple.co.uk](http://www.caple.co.uk)

## CONTENTS

---

Safety Instructions	3
Environmental Protection	9
Warranty	10
Quick Operation Guide	11
Control Panel	12
Product Overview	15
Water Softener	17
Loading the Salt into the Softener	19
Rinse Aid Dispenser	21
Filling The Detergent Dispenser	23
Loading The Dishwasher Baskets	25
Cutlery Rack Tips	28
Wash Cycle Table	34
Programming the Dishwasher	35
Auto Open	37
Cleaning and Maintenance	38
Installation Instructions	43
Troubleshooting	54
Error Codes	57
Technical Information	58
Caple Contact Details	60

## **SAFETY INSTRUCTIONS**

- This appliance is intended to be used in household and similar applications such as:
  - › Staff kitchen areas in shops, offices and other working environments.
  - › Farm Houses.
  - › By clients in hotels, motels and other residential type environments.
  - › Bed and breakfast type environments.
- This appliance can be used by children aged from 8 years and above and persons with reduced physical, sensory or mental capabilities or lack of experience and knowledge if they have been given supervision or instruction concerning use of the appliance in a safe way and understand the hazards involved. Children shall not play with the appliance. Cleaning and user maintenance shall not be made by children without supervision.
- This appliance is not intended for use by persons (including children) with reduced physical, sensory or mental capabilities, or lack of experience and knowledge, unless they have been given supervision or instruction concerning use of the appliance by a person responsible for their safety.
- This appliance is for indoor household use only.
- To protect against the risk of electrical shock, do not immerse the unit, cord or plug in water or other liquid.
- Please unplug before cleaning or performing maintenance

on the appliance.

- Use a slightly moistened soft cloth with mild soap, and then use a dry cloth to wipe it again.
- This appliance must be earthed. In the event of a malfunction or breakdown, earthing will reduce the risk of an electric shock by providing a path of less resistance of electric current. This appliance is equipped with a cord having an equipment-earthing conductor and a grounding plug.
- The plug must be plugged into an appropriate outlet that is installed and earthed in accordance with all local codes and regulations.
- Improper connection of the equipment-earthing conductor can result in the risk of an electric shock.
- Check with a qualified electrician or Caple service representative if you are in doubt whether the appliance is properly grounded.
- Do not modify the plug provided with the appliance; If it does not fit the outlet.
- Have a proper outlet installed by a qualified electrician.
- Do not abuse, sit on, or stand on the door or dish rack of the dishwasher.
- Do not operate your dishwasher unless all enclosure panels are properly in place.
- Open the door very carefully when the dishwasher is

- operating, there is a risk of water squirting out.
- Do not place any heavy objects on or stand on the door when it is open. The appliance could tip forward.
  - When loading items to be washed:
    - › Locate sharp items so that they are not likely to damage the door seal.
    - › Warning: Knives and other utensils with sharp points must be loaded in the basket with their points down or placed in a horizontal position.
  - Check that the detergent powder is empty after completion of the wash cycle.
  - Do not wash plastic items unless they are marked dishwasher safe or the equivalent.
  - For plastic items not marked, check the manufacturer's recommendations.
  - Use only detergent and rinse additives designed for an automatic dishwasher.
  - Never use soap, laundry detergent, or hand washing detergent in your dishwasher.
  - Children should be supervised to ensure that they do not play with the appliance.
  - The door should not be left open, since this could increase the risk of tripping.
  - The appliance may only be used with correctly adjusted door springs.

- If the supply cord is damaged, it must be replaced by Caple, its service agent or a similarly qualified person in order to avoid a hazard.
- During installation, the power supply must not be excessively or dangerously bent or flattened.
- The dishwasher must not be installed under a hob.
- Do not tamper with controls.
- The appliance is to be connected to the water mains using new hose sets and that old hose-sets should not be reused.
- To save energy, in stand by mode, the appliance will switch off automatically while there is no any operation in 30 minutes.

## **ELECTRICAL CONNECTION**

### **WARNINGS:**

- For personal safety:
- Do not use an extension cord or an adapter plug with this appliance.
- Do not, under any circumstances, cut or remove the earthing connection from the power cord.

### **ELECTRICAL REQUIREMENTS**

- Please look at the rating label to know the rating voltage and connect the dishwasher to the appropriate power supply. Use the required 10 amp fuse, time delay fuse or circuit breaker recommended and provide separate circuit serving only this appliance.

### **ELECTRICAL CONNECTION**

- Ensure the voltage and frequency of the power being corresponds to those on the rating label. Only insert the plug into an electrical socket which is earthed properly. If the electrical socket to which the appliance must be connected is not appropriate for the plug, replace the socket, rather than using a adapter as they could cause overheating and burns.

## GROUNDING INSTRUCTIONS

- This appliance must be earthed. In the event of a malfunction or breakdown, earthing will reduce the risk of electric shock by providing a path of least resistance for the electric current. This appliance is equipped with a cord having an equipment-earthing conductor and an earthing plug. The plug must be plugged into an appropriate outlet that is installed and earthed in accordance with all local standards and requirements.

## WARNING:

- Improper connection of the equipment grounding conductor can result in the risk of an electric shock. Check with a qualified electrician or service representative if you are in doubt whether the appliance is properly grounded. Do not modify the plug provided with the appliance; If it is not fit for the outlet. Have a proper outlet installed by a qualified electrician.





## ENVIRONMENTAL PROTECTION

Waste electrical products should not be disposed of with household waste. Please recycle where facilities exist. Check with your Local Authority or retailer for recycling advice. This appliance is marked according to the European directive on Waste Electrical and Electronic Equipment (WEEE).

By ensuring this product is disposed of correctly, you will help prevent potential negative consequences for the environment and human health, which could otherwise be caused by inappropriate waste handling of this product. The symbol on the product indicates that this product may not be treated as household waste. Instead it shall be handed over to the applicable collection point for the recycling of electrical and electronic equipment. Disposal must be carried out in accordance with local environmental regulations for waste disposal.

For more detailed information about treatment, recovery and recycling of this product, please contact your local council, your household waste disposal service or the retailer where you purchased the product.

## CE DECLARATIONS OF CONFORMITY

This appliance has been manufactured to the strictest standards and complies with all applicable legislation, Low Voltage Directive (LVD) and Electromagnetic Compatibility (EMC).

## UKCA DECLARATIONS OF CONFORMITY

This appliance has been manufactured to the strictest standards and complies with all applicable legislation.

## TECHNICAL FICHE

This appliance conforms to all current and applicable energy regulations. To view the Technical Fiche that supports the energy labelling data, please visit the product page on our website

[www.caple.co.uk](http://www.caple.co.uk)

## WARRANTY

Your new appliance is covered by warranty. The warranty card is enclosed - if it is missing, you must provide the following information to your retailer in order to receive a replacement: date of purchase, model and serial number. Registration can also be completed online by visiting **[www.caple.co.uk](http://www.caple.co.uk)**.

Ensure you keep your warranty card safe, you may need to show it to Caple Service together with proof of purchase.

If you fail to show your warranty card you will incur all repair charges. Spare parts are only available from Caple Service and spare parts authorised centres.

## QUICK OPERATION GUIDE

---

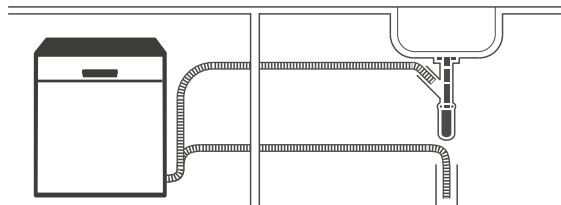

1. Install the dishwasher.



2. Remove large food residue from plates and cutlery.

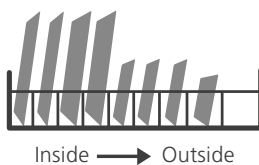

3. Load the baskets.

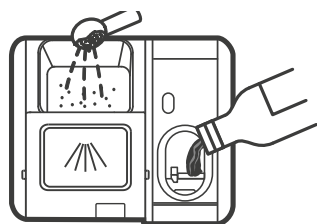

4. Fill the dispenser.







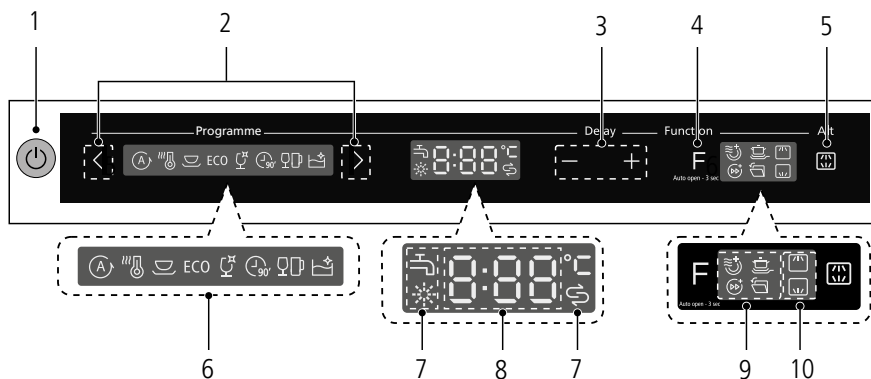











5. Select a programme and start the dishwasher.

## CONTROL PANEL



BUTTON	OPERATION	
1	POWER	Press the button to turn on your dishwasher, the screen lights up.
2	PROGRAMME	Press the “<” or “>” button to select a programme, and the corresponding indicator will be lit.
3	DELAY +/-	Press the “+” button to add the delay time or press the “-” button to decrease the delay time, maximum 24 hours delay can be defined.
4	FUNCTION	Press the button to select a function, corresponding indicator will be lit.
5	ALT	Press the button to select either upper basket or lower basket loaded, and the response indicators will be lit.

BUTTON	OPERATION	
6 PROGRAMME INDICATOR	AUTO 	For lightly, normally or heavily soiled crockery with or without dried-on food.
	HYGIENE 	With the sanitise option selected, the water temperature is increased to 70°C for high temperature sanitisation.
	UNIVERSAL 	For normally soiled loads, such as pots, plates, glasses and lightly soiled pans.
	ECO ECO	This is a standard programme, and is suitable to clean normally soiled tableware and is the most efficient programme in terms of its combined energy and water consumption for that type of tableware.
	GLASS 	For lightly soiled crockery and glass.
	90 MIN 	For normally soiled loads that need quick wash.
	PARTY 	For lightly soiled loads, such as glasses, crystal and fine china.
	SELF-CLEANING 	This programme provides an effective cleaning of the dishwasher itself.
7 WARNING INDICATOR	RINSE AID 	If the "☼" indicator is lit, it means the dishwasher is low on dishwasher rinse aid and requires a refill.
	SALT 	If the "⊞" indicator is lit, it means the dishwasher is low on dishwasher salt and needs to be refilled.
	WATER TAP 	If the "⌵" indicator is lit, it means the water tap is closed.
8 SCREEN	To show the remaining time and delay time, error codes etc.	

BUTTON	OPERATION	
9 FUNCTION INDICATOR	EXTRA DRYING 	To dry dishes more thoroughly. (It can only be used with Hygiene, Universal, ECO, Glass, 90 min)
	POWER WASH 	To wash heavily soiled, hard to clean dishes. (This can only be used with Hygiene, Universal, ECO, Glass, 90 min).
	EXPRESS WASH 	Reduce the programme time. (It can only be used with Hygiene, Universal, ECO, Glass, 90 min)
	AUTO OPEN 	The door will open automatically towards the end of the selected programme. This is to achieve a better drying effect. Press and hold the function button for 3 seconds to activate AUTO OPEN function - the corresponding indicator will illuminate.
10 ALT INDICATOR	UPPER 	When you select Upper, only the upper rack nozzle is activated. The lower nozzle will not operate.
	LOWER 	When you select Lower, only the lower rack nozzle is activated. The upper nozzle will not operate.

**NOTE:**

Indicator Lamp Function:

The Indicator lamp will be lit up during the washing programme, then blink for 5 minutes and turn off at end of the programme.

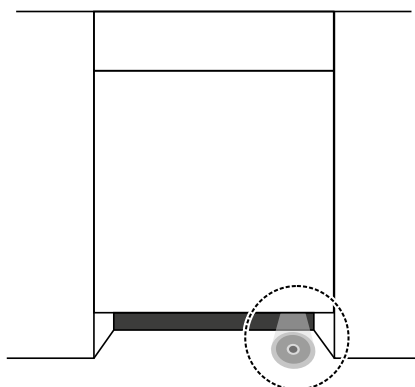

# PRODUCT OVERVIEW

## IMPORTANT:

To get the best performance from your dishwasher, read all operating instructions before using it

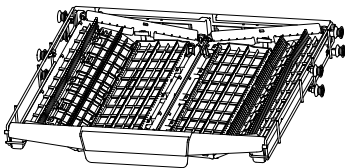
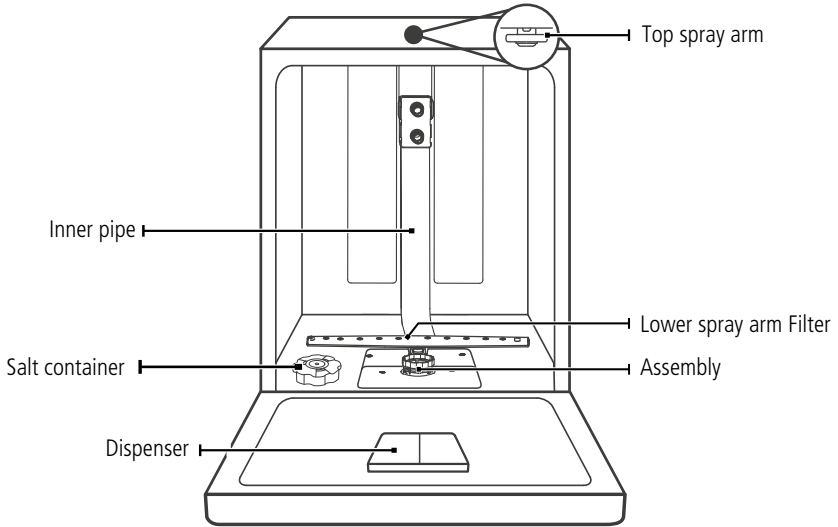

Cutlery Rack

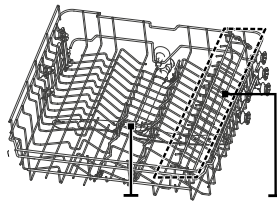

Upper spray arm

Upper basket



Wine glass holder

Lower Basket

## NOTE:

Images are for reference only.

## 360° WATER SPRAY SYSTEM

The innovative spray arm uses two separate rotating axes to maximise water spray to all corners of the dishwasher, ensuring every item receives an exceptional clean.

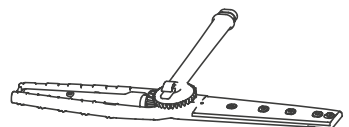

## PRIOR TO USING FOR THE FIRST TIME

Before using your dishwasher for the first time:

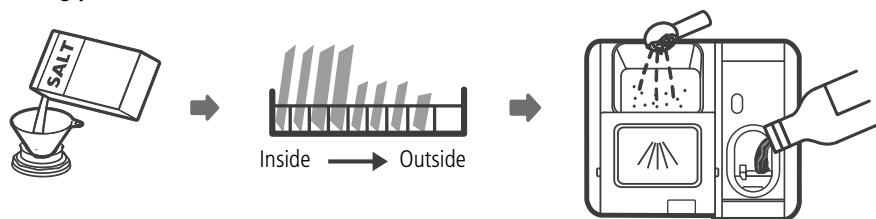

- › Set the water softener.
- › Add 1.5Kg dishwasher salt and then fill the salt container with water.
- › Fill the Rinse Aid dispenser.
- › Fill in detergent.



## WATER SOFTENER

---

The water softener must be set manually, using the water hardness dial.

The water softener is designed to remove minerals and salts from the water, which would have a detrimental or adverse effect on the operation of the appliance.

The higher the content of these minerals and salts, the harder your water is.

The softener should be adjusted according to the hardness of the water in your area. Your local Water Authority can advise you on the hardness of the water in your area.

### **ADJUSTING SALT CONSUMPTION**

The dishwasher is designed to allow for adjustment in the amount of salt consumed based on the hardness of the water used. This is intended to optimise and customise the level of salt consumption.

Please follow the steps below for adjustment in salt consumption:

1. Open the door and Switch on the appliance.
2. Within 60 seconds of the appliance being switched on, press the Programme button ">" for more than 5 seconds, then press "+" to start the water softening setting.
3. Press the Programme button again ">" to select the proper setting according to your local environment, the setting will change in the following sequence:  
H3 → H4 → H5 → H6 → H1 → H2 → H3
4. No operation in 5 seconds or pressing the Power button will complete the setup and exit the setup mode.

WATER HARDNESS				WATER SOFTENER LEVEL	REGENERATION OCCURS EVERY X PROGRAMME SEQUENCE*	SALT CONSUMPTION (GRAM/CYCLE)
GERMAN °DH	FRENCH °FH	BRITISH °CLARKE	MMOL/L			
0~5	0~9	0~6	0~0.94	H1	No regeneration	0
6-11	10-20	7-14	1.0-2.0	H2	10	9
12-17	21-30	15-21	2.1-3.0	H3	5	12
18-22	31-40	22-28	3.1-4.0	H4	3	20
23-34	41-60	29-42	4.1-6.0	H5	2	30
35-55	61-98	43-69	6.1-9.8	H6	1	60

°dH=1.25 °Clarke=1 1.78°fH=0.178mmol/l

The manufacturer setting: H3

Contact your local water board for information on the hardness of your water supply.

\*Every cycle with a regeneration operation consumes an additional 2.0 litres of water, the energy consumption increases by 0.02 kWh and the programme extends by 4 minutes.

#### NOTE:

The hardness of the water varies from place to place. If hard water is used in the dishwasher, deposits will form on the dishes and utensils.

The appliance is equipped with a special softener that uses a salt container specifically designed to eliminate lime and minerals from the water.

## LOADING THE SALT INTO THE SOFTENER

---

Always use salt intended for use with dishwashers.

The salt container is located beneath the lower basket and should be filled as explained in the following:

### **WARNING:**

- › Only use salt specifically designed for the use in dishwasher. Every other type of salt not specifically designed for the use in a dishwasher, especially table salt, will damage the water softener. In case of damages caused by the use of unsuitable salt the manufacturer does not give any warranty nor is liable for any damages caused.
- › Only fill with salt just before running a cycle. This will prevent any grains of salt or salty water, which may have been spilled, remaining on the bottom of the machine for any period of time, which may cause corrosion.

Please follow the steps below for adding dishwasher salt:

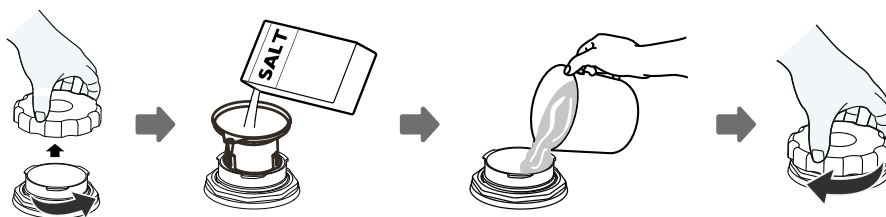

1. Remove the lower basket and unscrew the reservoir cap.
2. Place the end of the funnel (supplied) into the hole and pour in about 1.5kg of dishwasher salt.
3. Fill the salt container to its maximum limit with water, It is normal for a small amount of water to come out of the salt container.
4. After filling the container, screw back the cap tightly.  
The salt warning light will turn off after the salt container has been filled with salt.
5. Immediately after filling the salt into the salt container, a washing programme should be started (we suggest to use a short programme). Otherwise the filter system, pump or other important parts of the machine may be damaged by salty water.

**NOTE:**

- › The salt container must only be refilled when the salt warning light (  ) in the control panel comes on. Depending on how well the salt dissolves, the salt warning light may still be on even though the salt container is filled.
- › If salt has spilled, run a soak or quick programme to remove it.

## RINSE AID DISPENSER

---

The Rinse Aid is released during the final rinse to prevent water from forming droplets on your dishes, which can leave spots and streaks. It also improves drying by allowing water to roll off the dishes. Your dishwasher is designed to use liquid Rinse Aids.

### **WARNING:**

Only use branded Rinse Aid for dishwasher. Never fill the Rinse Aid dispenser with any other substances (e.g. Dishwasher cleaning agent, liquid detergent). This would damage the appliance.

### **FUNCTION OF RINSE AID:**

Rinse Aid is automatically added during the last rinse, ensuring thorough rinsing, and spot and streak free drying.

### **WHEN TO REFILL THE RINSE AID DISPENSER:**

The regularity of the dispenser needing to be refilled depends on how often dishes are washed and the rinse aid setting used.

- › The Low Rinse Aid indicator (  ) will be lit when more rinse aid is needed.
- › Do not overfill the rinse aid dispenser.

## FILL THE RINSE AID DISPENSER

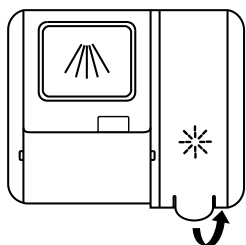

1. Remove the rinse aid cap by lifting up the handle .

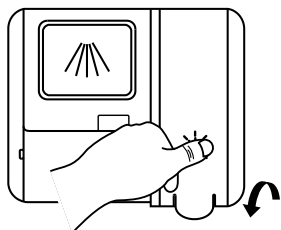

3. Close the cap once full.

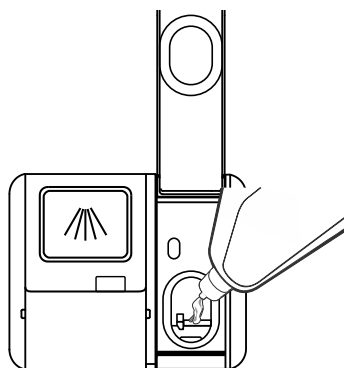

2. Pour the rinse aid into the dispenser, being careful not to overfill.

## ADJUST RINSE AID DISPENSER

To achieve a better drying performance with limited rinse aid, the dishwasher is designed to adjust the consumption by user. Follow the below steps:

1. Open the door, switch on the appliance.
2. Within 60 seconds of step 1, press and hold the Programme ">" button for more than 5 seconds, and then press the Delay "+ " button to enter the set model, the rinse aid indication blinks as 1Hz frequency.
3. Press the Programme button to select your desired setting. The settings will change in the following sequence: D1→D2→D3→D4→D5→D1. The higher the number, the more rinse aid the dishwasher uses.
4. No operation in 5 seconds or pressing the Power button will exit the setup mode.

## FILLING THE DETERGENT DISPENSER

### FUNCTION OF DETERGENT

The chemical ingredients that compose the detergent are necessary to remove, crush and dispense all dirt out of the dishwasher. Most of the commercial quality detergents are suitable for this purpose.

### PROPER USE OF DETERGENT

- › Use only detergent specifically made for dishwasher use. Keep your detergent fresh and dry.
- › Don't put powdered detergent into the dispenser until you are ready to wash dishes.

### FILLING THE DETERGENT DISPENSER

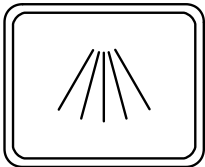

Sliding it to the right

1. Open the cap by pressing down the release catch.

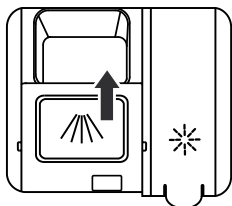

3. Close the flap by sliding it to the front and then pressing it down.

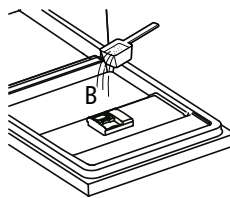
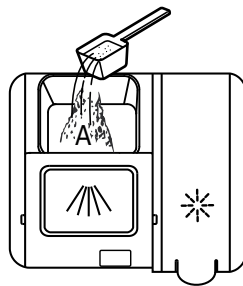

2. Add detergent into the larger cavity (A) for the main wash cycle.

For better cleaning result, especially if you have very dirty items, pour a small amount of detergent onto the door (B). The additional detergent will activate during the pre-wash phase.

**NOTE:**

Depending on how dirty the items are will affect how much detergent to use.

Please observe the manufacturers recommendations found on the detergent packing.

**WARNING:**

Dishwasher detergent is corrosive.

Keep dishwasher detergent out of the reach of children.



## LOADING THE DISHWASHER BASKETS

---

- › Consider buying utensils which are identified as dishwasher-proof.
- › For particular items, select a programme with the lowest possible temperature. To prevent damage, do not take glass and cutlery out of the dishwasher immediately after the programme has ended.

### **THE FOLLOWING CUTLERY DISHES ARE NOT SUITABLE:**

- › Cutlery with wooden, horn china or mother-of-pearl handles
- › Plastic items that are not heat resistant
- › Older cutlery with glued parts that are not temperature resistant Bonded cutlery items or dishes
- › Pewter or cooper items
- › Crystal glass
- › Steel items subject to rusting
- › Wooden platters
- › Items made from synthetic fibres

### **ARE OF LIMITED SUSTAINABILITY:**

- › Some types of glasses can become dull after a large number of washes
- › Silver and aluminium parts have a tendency to discolour during washing
- › Glazed patterns may fade if machine washed

### **RECOMMENDATIONS FOR LOADING THE DISHWASHER**

Scrape off any large amounts of leftover food. Soften remnants of burnt food in pans. It is not necessary to rinse the dishes under running water.

For best performance of the dishwasher, follow these loading guidelines.

## **(FEATURES AND APPEARANCE OF BASKETS AND CUTLERY BASKETS MAY VARY FROM YOUR MODEL.)**

Place objects in the dishwasher in following way:

- › Items such as cups, glasses, pots/pans, etc. are faced downwards.
- › Curved items, or ones with recesses, should be loaded aslant so that water can run off.
- › All utensils are stacked securely and can not tip over.
- › All utensils are placed in the way that the spray arms can rotate freely during washing.
- › Load hollow items such as cups, glasses, pans etc. With the opening facing downwards so that water cannot collect in the container or a deep base.
- › Dishes and items of cutlery must not lie inside one another, or cover each other. To avoid damage, glasses should not touch one another.
- › The upper basket is designed to hold more delicate and lighter dish ware such as glasses, coffee and tea cups.
- › Long bladed knives stored in an upright position are a potential hazard.
- › Long and / or sharp items of cutlery such as carving knives must be positioned horizontally in the upper basket.
- › Please do not overload your dishwasher. This is important for good results and for reasonable consumption of energy.

### **NOTE:**

Very small items should not be washed in the dishwasher as they could easily fall out of the basket.

## **REMOVING THE DISHES**

To prevent water dripping from the upper basket into the lower basket, we recommend that you empty the lower basket first, followed by the upper basket.

### **WARNING:**

Items will be hot.

To prevent damage, do not take glass and cutlery out of the dishwasher for around 15 minutes after the programme has ended.



## LOADING THE UPPER BASKET

The upper basket is designed to hold more delicate and lighter dish ware such as glasses, coffee and tea cups and saucers, as well as plates, small bowls and shallow pans (as long as they are not too dirty). Position the dishes and cookware so that they will not get moved by the spray of water.

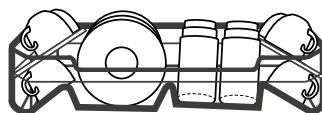

## LOADING THE LOWER BASKET

We suggest that you place large items and the most difficult to clean items into the lower basket: such as pots, pans, lids, serving dishes and bowls, as shown in the figure below. It is preferable to place serving dishes and lids on the side of the racks in order to avoid blocking the rotation of the top spray arm.

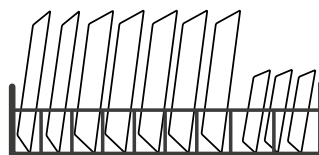

The maximum diameter advised for plates in front of the detergent dispenser is of 19cm, this is so not to prevent it opening.

## LOADING THE CUTLERY TRAY

Cutlery should be placed in the cutlery rack separately from each other in the appropriate positions. Make sure the utensils do not nest together, this may cause bad performance.

## CUTLERY RACK TIPS

---

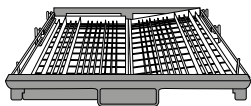

Left basket is flat and right basket is tilted.

---

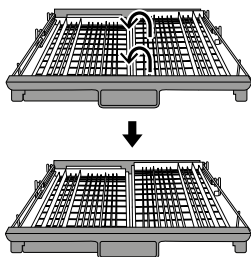

Lift the right basket up, both left and right baskets are flat.

---

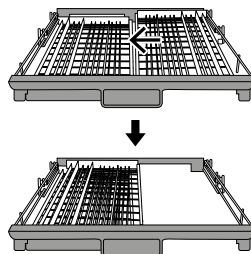

Move the right basket from right to left leaving the two baskets overlapping.

---

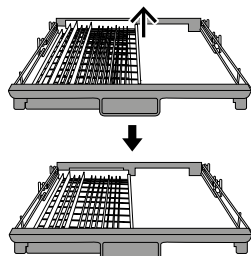

Remove the right basket from the tray, only leaving the left basket.

## ADJUSTING THE UPPER BASKET

The height of the upper basket can be easily adjusted to accommodate taller dishes in either the upper or lower basket.

To adjust the height of the upper rack, follow these steps:

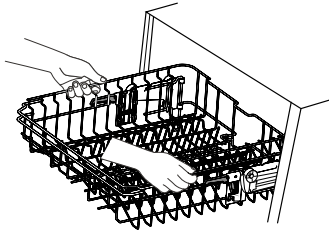

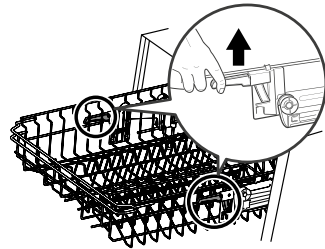

1. To raise the upper basket, just lift the upper basket at the center of each side until the basket locks into place in the upper position. It is not necessary to lift the adjuster handle.



2. To lower the upper basket, lift the adjuster handles on each side to release the basket and lower it to the lower position.

## USING THE WINE GLASS SUPPORT:

You can load cups or glasses onto the glass support. This is also very convenient for washing wine glasses. Hang your wine glasses onto the pegs of the glass support. Please determine the position according to the size of the wine glasses.

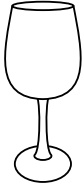
		
<p><b>SMALL GLASS</b></p>	<p><b>MIDDLE GLASS</b></p>	<p><b>LARGE GLASS</b></p>
<p>&lt;120 mm</p>	<p>&lt;180 mm (With the third tray) &lt;250mm (Without the third tray)</p>	<p>&lt;250mm</p>

## LOWER BASKET

Large glasses are placed on the lower basket. Please fold down the last row of folding spikes before placing the wine glasses.

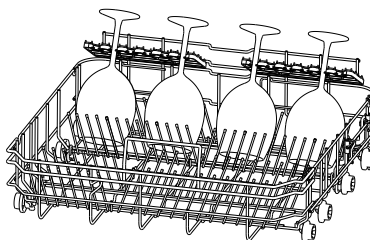

To make room for taller items in the upper basket, raise the cup rack upwards. You can then lean the tall glasses against it. You can also remove it when it is not required for use.



## FOLDING BACK THE RACK SHELVES

The spikes of the lower basket are used for holding plates and a platter. They can be lowered to make more room for large items.

### RAISE UPWARDS

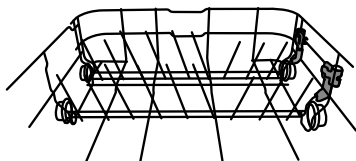

### FOLD DOWNWARDS

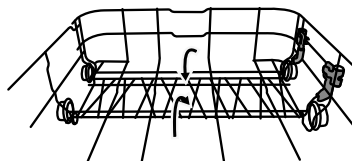

**UPPER BASKET:**

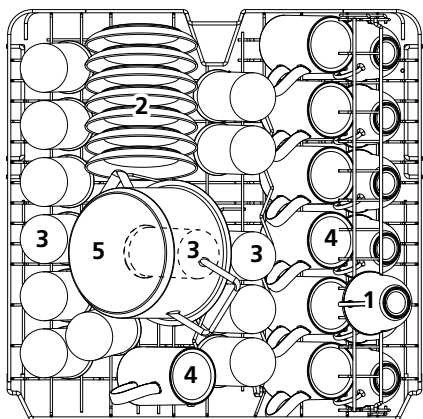

NUMBER	ITEM
1	Cups
2	Saucers
3	Glasses
4	Mugs
5	Small pot

**LOWER BASKET:**

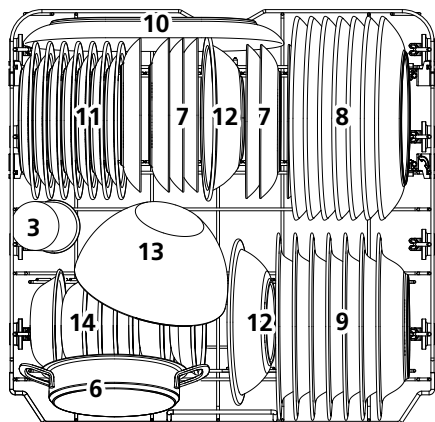

NUMBER	ITEM
6	Oven pot
7	Dessert Plates
8	Dinner Plates
9	Soup Plates
10	Oval Platter
11	Melamine dessert plates
12	Melamine bowls
13	Glass bowl
14	Dessert bowls



## CUTLERY RACK:

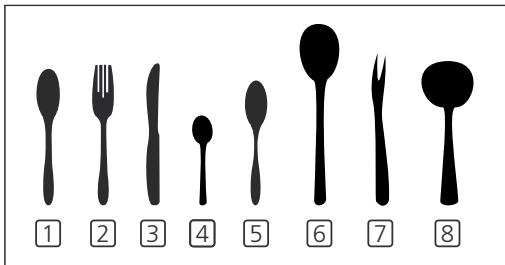
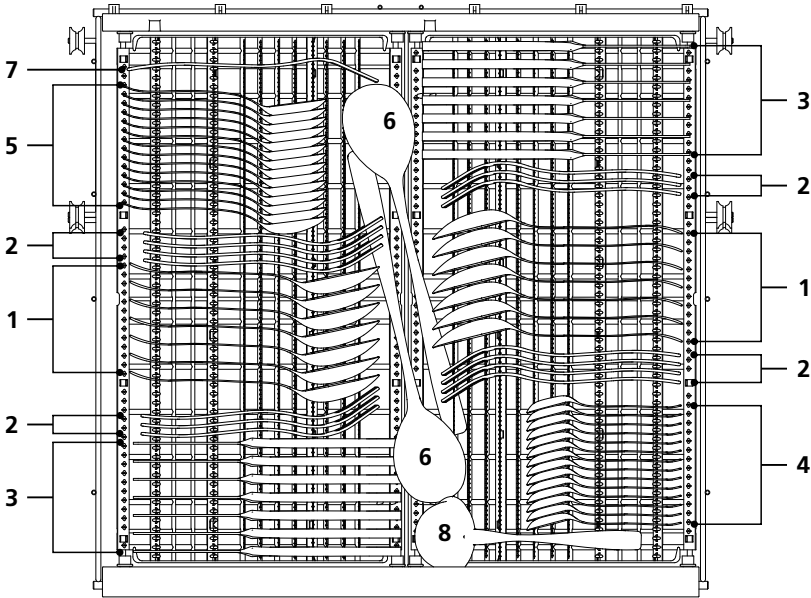

NUMBER	ITEM
1	Soup spoons
2	Forks
3	Knives
4	Teaspoons
5	Dessert spoons
6	Serving spoons
7	Serving forks
8	Gravy ladle

Information for comparability tests in accordance with EN 60436 Capacity: 14 place settings

Position of the upper basket: lower position  
Programme: ECO

Rinse aid setting: Max

Softener setting: H3

## WASH CYCLE TABLE

★ Means: Fill Rinse Aid into the Rinse-Aid Dispenser.

PROGRAMME	DESCRIPTION OF CYCLE	DETERGENT PRE/MAIN	RUNNING TIME (MIN)	ENERGY (KWH)	WATER (L)	RINSE AID
 AUTO	Pre-wash (45°C) Auto wash (55-65°C) Rinse Rinse (50-55°C) Drying	4/18g (1 or 2 pieces)	85-150	0.850 -1.550	8.5-18.7	★
 HYGIENE	Wash (72°C) Rinse Rinse Rinse (72°C) Drying	22g (1 or 2 pieces)	215	1.815	14.9	★
 UNIVERSAL	Pre-wash (45°C) Wash (55°C) Rinse Rinse (55°C) Drying	4/18g (1 Or 2 pieces)	175	1.230	14.8	★
 ECO (*EN 60436)	Pre-wash Wash (50°C) Rinse Rinse (40°C) Drying	4/18g (1 Or 2 pieces)	235	0.645	9.8	★
 GLASS	Pre-wash Wash (50°C) Rinse (50°C) Rinse (50°C) Drying	4/18g (1 Or 2 pieces)	120	0.995	14.8	★
 90 MIN	Wash (60°C) Rinse Rinse (50°C) Drying	22g (1 piece)	90	1.180	11.9	★
 PARTY	Wash (35°C) Rinse (35°C)	12g (1 piece)	20	0.410	11.3	
 SELF-CLEAN	Pre wash Wash (60°C) Rinse Rinse (60°C) Drying	4/18g (1 or 2 pieces)	145	1.405	15.1	★

\*This programme is the test cycle. The information for comparability test in accordance with EN 60436

## PROGRAMMING THE DISHWASHER

---

### STARTING A WASH CYCLE

1. Draw out the lower and upper basket, load the dishes and push them back.  
It is recommended to load the lower basket first, then the upper one.
2. Pour in the detergent.
3. Insert the plug into the socket. See appliance Rating Label for further information on the power supply. Make sure that the water supply is turned on to full pressure.
4. Open the door, press the Power button.
5. Press the Programme “ < ” button or “ > ” button to choose a programme, the response light will turn on. Then close the door, the dishwasher will start its cycle.

### CHANGING THE PROGRAMME MID-CYCLE

A wash cycle can only be changed if it has been running for a short time otherwise, the detergent may have already been released and the dishwasher may have already drained the wash water. If this is the case, the dishwasher needs to be reset and the detergent dispenser must be refilled. To reset the dishwasher, follow the instructions below:

6. Open the door a little to stop the dishwasher, after the spray arm stops working, you can open the door completely.
7. Press and hold the Programme “ > ” button for more than three seconds and the machine will be in the programme selection mode.
8. You can change the programme to the desired cycle setting.

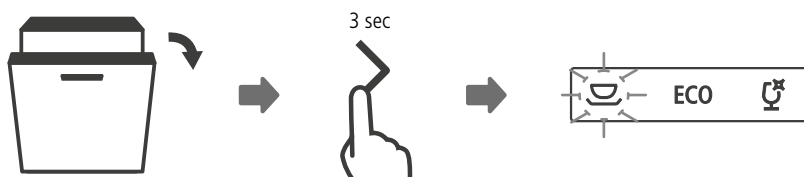

## FORGOT TO ADD A DISH

A forgotten dish can be added any time before the detergent dispenser opens. If this is the case, follow the instructions below:

- › Open the door a little to stop the washing.
- › After the spray arms stop working, you can open the door completely.
- › Add the forgotten dishes.



- › Close the door. The dishwasher will start after 10 seconds.

### WARNING:

- › It is dangerous to open the door mid-cycle, as hot steam may scald you.



## AUTO OPEN

---

The door will open automatically towards the end of the selected programme. This is to achieve a better drying effect. The dishwasher will sound an audible tone when the full cycle is complete.

Once the programme has ended, wait for a few minutes before unloading the dishwasher to avoid handling the dishes and utensils while they are still hot and more susceptible to breakage. This will also assist with the drying.

### **NOTE:**

The dishwasher door must not be blocked when set to open automatically. This can disrupt door lock functionality.

## **UNLOADING THE DISHWASHER**

It is normal that the dishwasher is wet inside. Empty the lower basket first and then the upper one. This will avoid water dripping from the upper Basket onto the dishes in the lower one.

## CLEANING AND MAINTENANCE

---

### FILTERING SYSTEM

The filter prevents larger remnants of food or other objects from getting inside the pump. The residues may block the filter, in this case they must be removed.

The filter system consists of a coarse filter, a flat (Main filter) and a microfilter (Fine filter).



#### 1. COARSE FILTER

Larger items, such as pieces of bones or glass, that could block the drain are trapped in the coarse filter. To remove items caught by the coarse filter, gently squeeze the tabs on the top of the filter and lift out.

#### 2. MAIN FILTER

Food and soil particles trapped in this filter are pulverised by a special jet on the lower spray arm and washed down the drain.



#### 3. FINE FILTER

This filter holds soil and food residues in the sump area and prevents it from being deposited on the dishes during wash cycle.

### FILTER ASSEMBLY

The filter efficiently removes food particles from the wash water, allowing it to be recycled during the cycle. For best performance and results, the filter must be cleaned regularly. For this reason, it is a good idea to remove the larger food particles trapped in the filter after each wash cycle by rinsing the semicircular filter and cup under running water. To remove the filter device, turn the filter anti-clockwise and pull the filter in the upwards direction.

#### NOTE:

The entire filter assembly should be cleaned once a week.

## CLEANING THE FILTER

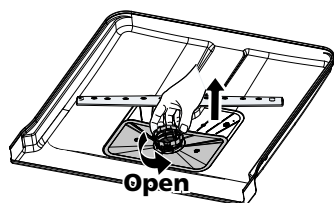

1. Hold the coarse filter and rotate it anticlockwise to unlock the filter. Lift the filter upwards and out of the dishwasher.

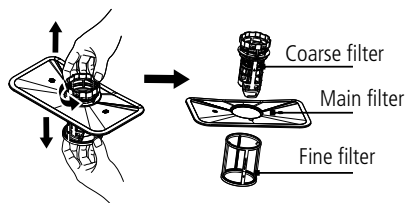

2. The fine filter can be pulled off the bottom of the filter assembly. The coarse filter can be detached from the main filter by gently squeezing the tabs at the top and pulling it away.

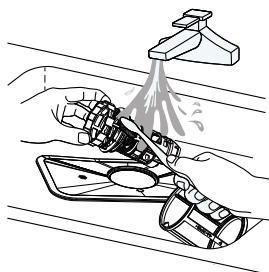

3. Larger food remnants can be cleaned by rinsing the filter under running water. For a more thorough clean, use a soft cleaning brush.

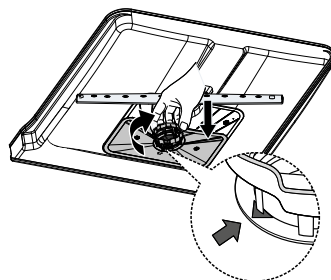

4. Reassemble the filters in the reverse order of the disassembly, replace the filter insert, and rotate clockwise to the close arrow.

### WARNING:

- › Improper replacement of the filter may reduce the performance level of the appliance and damage dishes and utensils.
- › The dishwasher must never be used without the filters.
- › Do not over tighten the filters. Put the filters back in sequence securely, otherwise coarse debris could get into the system and cause a blockage.

## CONTROL PANEL AND EXTERIOR

The control panel can be cleaned by using a lightly dampened cloth only. After cleaning, make sure to dry it thoroughly.

For the exterior, use a good appliance polish wax. Never use sharp objects, scouring pads or harsh cleaners on any part of the dishwasher.

## CLEANING THE DOOR AND DOOR SEAL

Clean the door seals regularly with a soft damp cloth to remove food deposits. When the dishwasher is being loaded, food and drink residues may drip onto the sides of the dishwasher door. These surfaces are outside the wash cabinet and are not accessed by water from the spray arms. Any deposits should be wiped off before the door is closed.

### WARNING:

- › Never use a spray cleaner to clean the door panel as it may damage the door lock and electrical components.
- › Abrasive agents or some paper towels should not be used because of the risk of scratching or leaving spots on the stainless steel surface.

## PROTECT AGAINST FREEZING

Please take frost protection measures on the dishwasher in winter. After every wash cycle please operate as follows:

1. Cut off the electrical power to the dishwasher.
2. Turn off the water supply and disconnect the water inlet pipe from the water valve.
3. Drain the water from the inlet pipe and water valve. (Use a pan to gather the water).
4. Reconnect the water inlet pipe to the water valve.
5. Remove the filter at the bottom of the dishwasher and use a sponge to soak up water in the sump.

### NOTE:

If your dishwasher cannot work because of the ice build up, please contact a qualified plumber or serviceman.



## CLEANING THE SPRAY ARMS

To clean the spray arms, follow the instructions below:

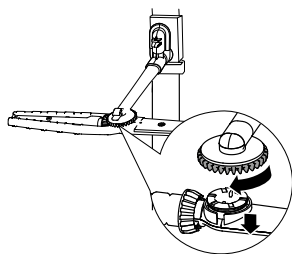

1. To remove the upper spray arm, hold the nut in the centre still and rotate the spray arm counter-clockwise to remove it.

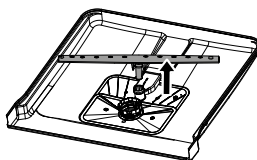

2. To remove the lower spray arm, pull out the spray arm upward.

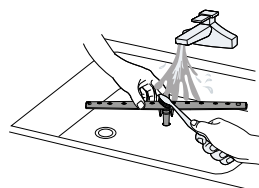

3. Wash the arms in soapy and warm water and use a soft brush to clean the jets. Replace them after rinsing them thoroughly.

## HOW TO KEEP YOUR DISHWASHER IN SHAPE AFTER EVERY WASH

After every wash, turn off the water supply to the appliance and leave the door slightly open so that moisture and odours are not trapped inside.

## REMOVE THE PLUG

Before cleaning or performing maintenance, always remove the plug from the socket.

## NO SOLVENTS OR ABRASIVE CLEANING

To clean the exterior and rubber parts of the dishwasher, do not use solvents or abrasive cleaning products. Only use a cloth with warm soapy water. To remove spots or stains from the surface of the interior, use a cloth dampened with water and a little vinegar, or a cleaning product made specifically for dishwashers.

## **WHEN NOT IN USE FOR A LONG TIME**

It is recommend that you run a wash cycle with the dishwasher empty and then remove the plug from the socket, turn off the water supply and leave the door of the appliance slightly open. This will help the door seals to last longer and prevent odours from forming within the appliance.

## **MOVING THE APPLIANCE**

If the appliance must be moved, try to keep it in the vertical position. If absolutely necessary, it can be positioned on its back.

## **SEALS**

One of the factors that causes odours to form in the dishwasher is food that remains trapped in the seals. Periodic cleaning with a damp sponge will prevent this from occurring.

## INSTALLATION INSTRUCTIONS

---

### **ATTENTION:**

We strongly recommend the installation of the pipes and electrical connections should be made by a qualified engineer or similarly qualified professional.

### **WARNING:**

Electrical Shock Hazard. Disconnect electrical power before installing dishwasher. Failure to do so can result in death or electrical shock.

### **INSTALLATION PREPARATION**

The installation position of dishwasher should be near the existing inlet and drain hoses and power cord. One side of the cabinet sink should be chosen to facilitate the connection of drain hoses of the dishwasher.

### **NOTE:**

Please check the accompanying installation accessories (fixing for aesthetic door panel).

## WATER SUPPLY AND DRAIN

### COLD WATER CONNECTION

Connect the cold water supply hose to a threaded 3/4 inch connector and make sure that it is fastened tightly in place. If the water pipes are new or have not been used for an extended period of time, let the water run to make sure that the water is clear. This precaution is needed to avoid the risk of the water inlet to be blocked and damaged.

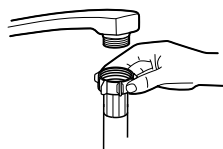

ordinary supply hose



safety supply hose

### ABOUT THE SAFETY SUPPLY HOSE

The safety supply hose consists of the double walls. The hose's system guarantees its intervention by blocking the flow of water in case of the supply hose breaking and when the air space between the supply hose itself and the outer corrugated hose is full of water.

#### WARNING

A hose that attaches to a tap can burst if it is installed on the same water line as the dishwasher. If your sink has one, it is recommended that the hose be disconnected and the hole plugged.

### HOW TO CONNECT THE SAFETY SUPPLY HOSE

1. Pull the safety supply hoses completely out from storage compartment located at rear of dishwasher.
2. Tighten the screws of the safety supply hose to the faucet with thread 3/4inch.
3. Turn the water fully on before starting the dishwasher.

### HOW TO DISCONNECT THE SAFETY SUPPLY HOSE

1. Turn off the water.
2. Unscrew the safety supply hose from the faucet.

### CONNECTION OF DRAIN HOSES

Insert the drain hose into a drain pipe with a minimum diameter of 4cm, or let it run into the sink, making sure to avoid bending or crimping it. The height of drain pipe must be less than 100cm. The free end of the hose must not be immersed in water to avoid the back flow of it.

## WARNING:

Please securely fix the drain hose in either position A or position B:

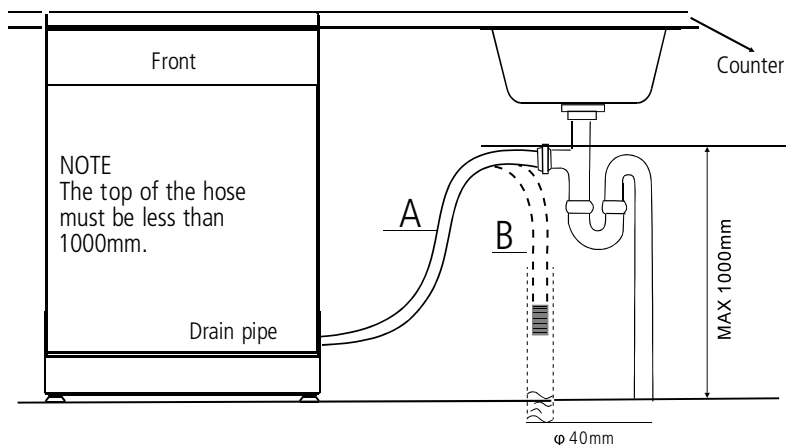

## HOW TO DRAIN EXCESS WATER FROM HOSES

If the sink is higher than 100cm from the floor, the excess water in hoses cannot be drained directly into the sink. It will be necessary to drain excess water from hoses into a bowl or suitable container that is held outside and lower than the sink.

## WATER OUTLET

Connect the water drain hose. The drain hose must be correctly fitted to avoid water leaks. Ensure that the water drain hose is not kinked or squashed.

## EXTENSION HOSE

If you need a drain hose extension, make sure to use a similar drain hose. It must be no longer than 4 metres; otherwise the cleaning effect of the dishwasher could be reduced.

## SYPHON CONNECTION

The waste connection must be at a height less than 100cm (maximum) from the bottom of the dishwasher. The water drain hose should be fixed.

## POSITION THE APPLIANCE

Position the appliance in the desired location. The back should rest against the wall behind it, and the sides, along the adjacent cabinets or walls. The dishwasher is equipped with water supply and drain hoses that can be positioned either to the right or the left sides to facilitate proper installation.

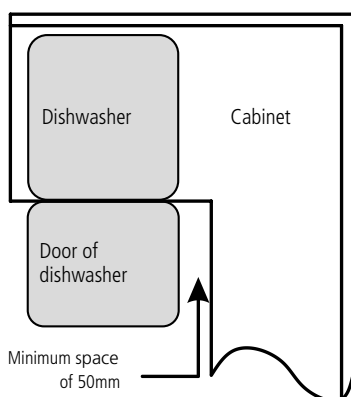
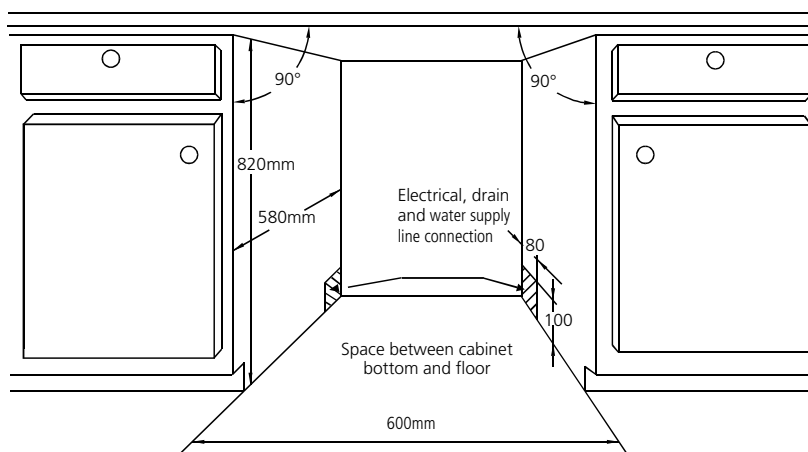

### NOTE:

Depending on where your electrical outlet is, you may need to cut a hole in the opposite cabinet side.

## FURNITURE DOOR INSTALLATION

Install the hook on the furniture door panel (see figure A) and put the hook into the slot of the outer door of dishwasher (see figure B). After positioning the panel, it should be fixed by two screws in two lower installation holes (see figure C). After tightening the screws, two rubber plugs should be placed into the holes to avoid trapping fingers.

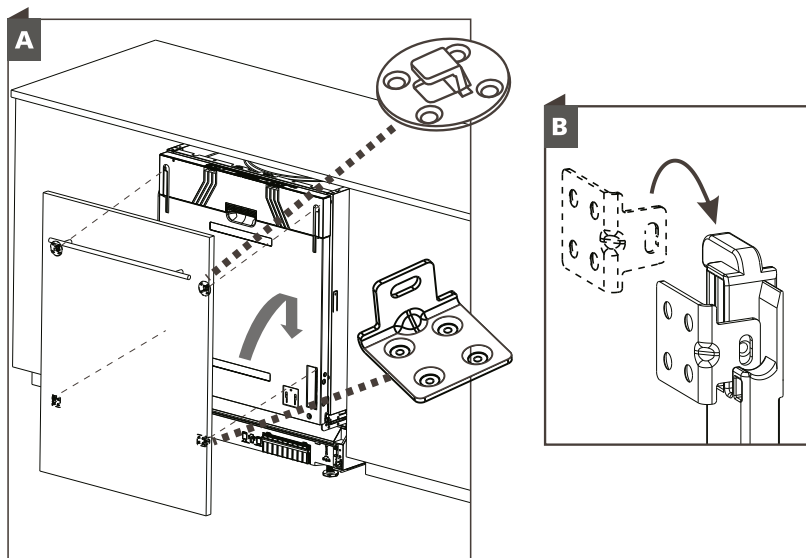

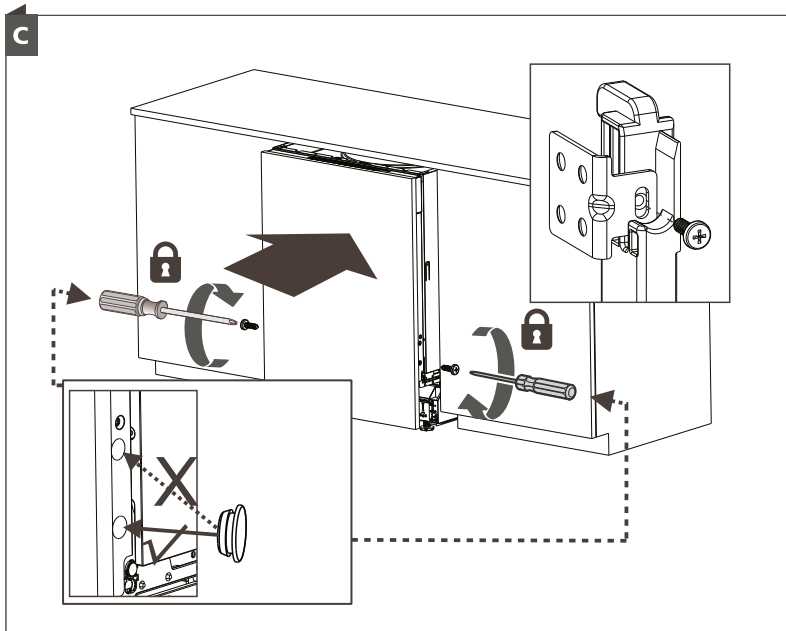
**NOTE:**

The furniture door weight should be 4-10KG with a Sliding Door and 5-7KG without a sliding door.

**WARNING:**

In any case, do not insert your fingers into the holes in the side of the dishwasher door. Do not leave the installation holes open after installation to avoid potential injury.

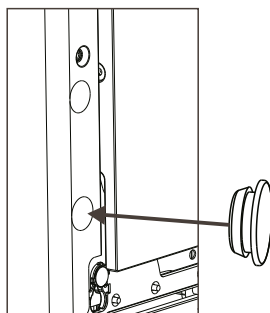
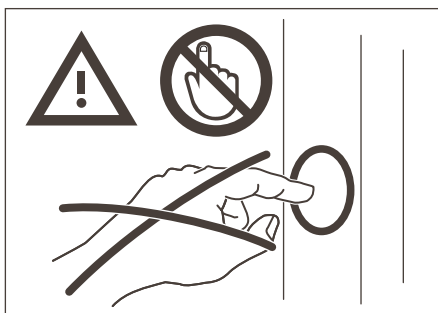



## DISHWASHER INSTALLATION STEPS

1. Fix the condensation strip under the work surface of cabinet. Please ensure the condensation strip is flush with edge of work surface.
2. Connect the inlet hose to the cold water supply.
3. Connect the drain hose.
4. Connect the power cord.
5. Place the dishwasher into position.
6. Level the dishwasher. The rear foot can be adjusted from the front of the dishwasher by turning the Philips screw in the middle of the base of dishwasher. To adjust the front feet, use a flat screw driver and turn the front feet until the dishwasher is level.
7. Install the furniture door to the outer door of the dishwasher.
8. The dishwasher must be secured in place. There are two ways to do this:
  - A. Normal work surface: Put the installation hook into the slot of the side plane and secure it to the work surface with the wood screws.
  - B. Marble or granite work top: Fix the side with screw.

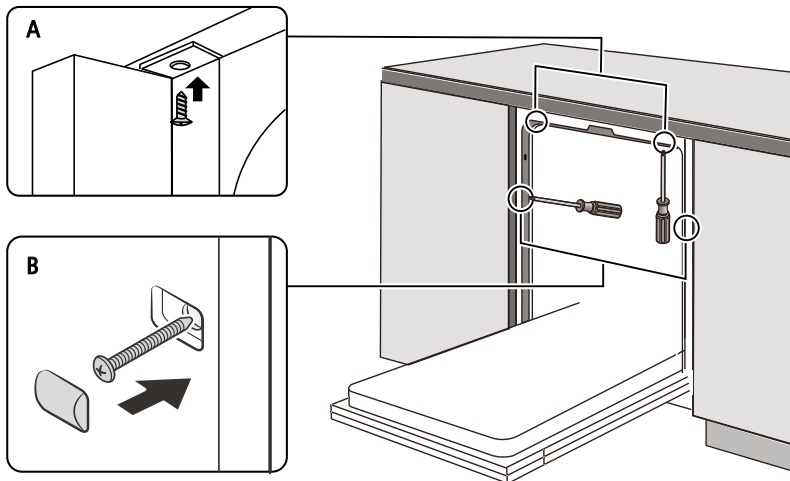

## LEVELLING THE DISHWASHER

The Dishwasher must be level for proper dish rack operation and wash performance.

1. Place a spirit level on the door and rack track inside the tub as shown to check that the dishwasher is level.
2. Level the dishwasher by adjusting the three levelling feet individually.
3. When levelling the dishwasher, please pay attention not to let the dishwasher tip over.

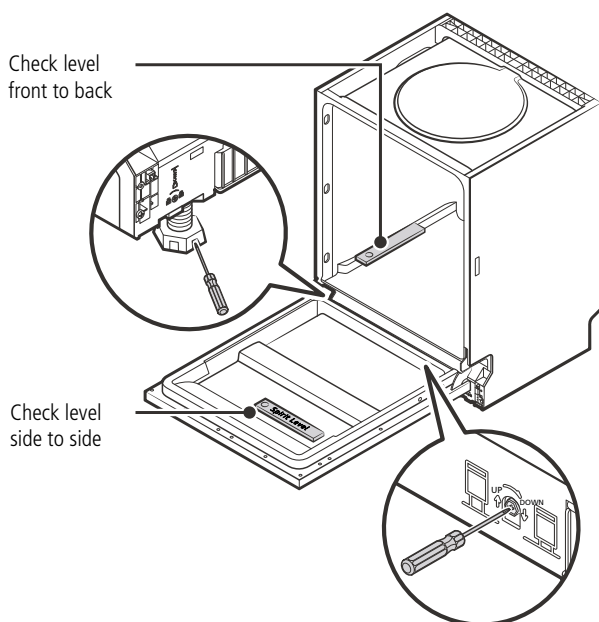

### NOTE:

The maximum adjustment height of the feet is 50mm.

### FEET EXTENSIONS:

Feet extensions are supplied. These can be fitted by inserting into the base of the existing feet, and tightening the locking nut at the top of the feet extensions to secure them into position.

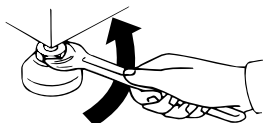

## SOUND-ABSORBING STRIP INSTALLATION

Sound-absorbing strip

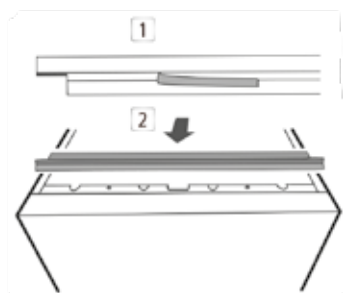
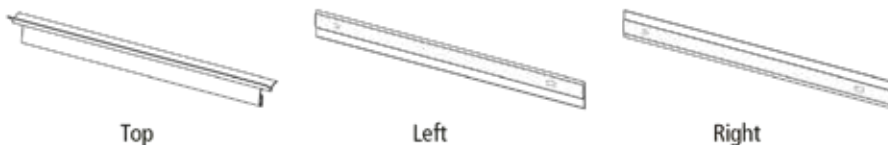

1. Remove the protection from the sound-absorbing strip, then fix the strip on the frame.



2. Take away the four screws from the right and left side plates.

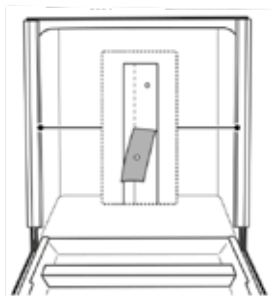

3. Remove the protection from the sound-absorbing strips, then stick the strips to the side plates, please align to the hole position.

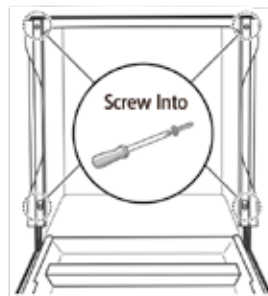

4. Screw on the screws.

## ELECTRICAL CONNECTION

### WARNING:

For personal safety:

- › Do not use an extension cord or an adapter plug with this appliance.
- › Do not, under any circumstances, cut or remove the earthing connection from the power cord.

## ELECTRICAL REQUIREMENTS

Please look at the rating label to know the rating voltage and connect the dishwasher to the appropriate power supply. Use the required 10 amp fuse, time delay fuse or circuit breaker recommended and provide separate circuit serving only this appliance.

## ELECTRICAL CONNECTION

Ensure the voltage and frequency of the power corresponds to those on the rating label. Only insert the plug into an electrical socket which is earthed properly. If the electrical socket to which the appliance must be connected is not appropriate for the plug, replace the socket, rather than using an adapter as they could cause overheating and burns.

## GROUNDING INSTRUCTIONS

This appliance must be earthed. In the event of a malfunction or breakdown, earthing will reduce the risk of electric shock by providing a path of least resistance for the electric current. This appliance is equipped with a cord having an equipment-earthing conductor and an earthing plug. The plug must be plugged into an appropriate outlet that is installed and earthed in accordance with all local standards and requirements.

### WARNING:

Improper connection of the equipment grounding conductor can result in the risk of an electric shock. Check with a qualified electrician or service representative if you are in doubt whether the appliance is properly grounded. Do not modify the plug provided with the appliance, if it is not fit for the outlet. Have a proper outlet installed by a qualified electrician.

### WARNING:

Please close the hydrant after using.

### ATTENTION:

After installation, please make sure to keep this manual. The content of this manual is very helpful to the users.

## **START THE DISHWASHER**

The following things should be checked before starting the dishwasher:

1. The dishwasher is level and fixed properly.
2. The inlet valve is open.
3. There is no leakage at the connection points.
4. The wires are tightly connected.
5. The power is switched on.
6. The inlet and drain hoses are not knotted.
7. All packing materials and printings should be taken out from the dishwasher.

## TROUBLESHOOTING

### BEFORE CALLING FOR SERVICE

Reviewing the charts on the following pages may save you from calling for service.

PROBLEM	POSSIBLE CAUSES	WHAT TO DO
DISHWASHER DOESN'T START	Fuse blown, or the circuit break tripped.	Replace fuse or reset circuit breaker. Remove any other appliances sharing the same circuit with the dishwasher.
	Power supply is not turned on.	Make sure the dishwasher is turned on and the door is closed securely. Make sure the power cord is properly plugged into the wall socket.
	Water pressure is low.	Check that the water supply is connected properly and the water is turned on.
	Door of dishwasher not properly closed.	Make sure to close the door properly and latch it.
WATER NOT PUMPED FROM DISHWASHER	Twisted or trapped drain hose.	Check the drain hose.
	Filter clogged.	Check the filter.
	Kitchen sink clogged.	Check the kitchen sink to make sure it is draining well. If the problem is the kitchen sink that is not draining, you may need a plumber rather than a serviceman for dishwashers.
SUDS IN THE TUB	Wrong detergent.	Use only the special dishwasher detergent to avoid suds. If this occurs, open the dishwasher and let suds evaporate. Add 1 litre of cold water to the bottom of the dishwasher. Close the dishwasher door, then select any cycle. Initially, the dishwasher will drain out the water. Open the door after draining stage is complete and check if the suds have disappeared. Repeat if necessary.
	Spilled rinse-aid.	Always wipe up rinse-aid spills immediately.
STAINED TUB INTERIOR	Detergent with colourant may have been used.	Make sure that the detergent has no colourant.

PROBLEM	POSSIBLE CAUSES	WHAT TO DO
WHITE FILM ON INSIDE SURFACE	Hard water minerals.	To clean the interior, use a damp soft cloth with dishwasher detergent and wear rubber gloves. Never use any other cleaner than dishwasher detergent otherwise, it may cause foaming or suds.
THERE ARE RUST STAINS ON CUTLERY	The affected items are not corrosion resistant.	Avoid washing items that are not corrosion resistant in the dishwasher.
	A programme was not run after dishwasher salt was added. Traces of salt have gotten into the wash cycle.	Always run a wash programme without any crockery after adding salt. Do not select the Turbo function (if present), after adding dishwasher salt.
	The lid of the softer is loose.	Check the softener lid is secure.
KNOCKING NOISE IN THE DISHWASHER	A spray arm is knocking against an item in a basket.	Interrupt the programme and rearrange the items which are obstructing the spray arm.
RATTLING NOISE IN THE DISHWASHER	Items of crockery are loose in the dishwasher.	Interrupt the programme and rearrange the items of crockery.
KNOCKING NOISE IN THE WATER PIPES	This may be caused by on-site installation or the cross-section of the piping.	This has no influence on the dishwasher function. If in doubt, contact a qualified plumber.
THE DISHES ARE NOT CLEAN	The dishes were not loaded correctly.	See "Loading the dishwasher baskets" pg 19
	The programme was not powerful enough.	Select a more intensive programme.
	Not enough detergent was dispensed.	Use more detergent, or change your detergent.
	Items are blocking the movement of the spray arms.	Rearrange the items so that the spray can rotate freely.
	The filter combination is not clean or is not correctly fitted in the base of wash cabinet. This may cause the spray arm jets to get blocked.	Clean and/or fit the filter correctly. Clean the spray arm jets.

CLOUDINESS ON GLASSWARE.	Combination of soft water and too much detergent.	Use less detergent if you have soft water and select a shorter cycle to wash the glassware and to get them clean.
WHITE SPOTS APPEAR ON DISHES AND GLASSES.	Hard water area can cause limescale deposits.	Add more detergent.
BLACK OR GREY MARKS ON DISHES	Aluminium utensils have rubbed against dishes	Use a mild abrasive cleaner to eliminate those marks.
DETERGENT LEFT IN DISPENSER	Dishes block detergent dispenser.	Re-loading the dishes properly.
THE DISHES AREN'T DRYING	Improper loading.	Load the dishwasher as suggested in the directions.
	Dishes are removed too soon.	Do not empty your dishwasher immediately after washing. Open the door slightly so that the steam can come out. Take out the dishes until the inside temperature is safe to touch. Unload the lower basket first to prevent the water dropping from the upper basket.
	Wrong programme has been selected.	With a short programme, the washing temperature is lower, decreasing cleaning performance. Choose a programme with a long washing time.
	Use of cutlery with a low-quality coating.	Water drainage is more difficult with these items. Cutlery or dishes of this type are not suitable for washing in the dishwasher.



## ERROR CODES

---

If there is a malfunction, the dishwasher will display error codes to identify these:

CODES	MEANINGS	POSSIBLE CAUSES
E1	Longer inlet time.	Tap is not opened, or water intake is restricted, or water pressure is too low.
E3	Not reaching required temperature.	Malfunction of heating element.
E4	Overflow.	Some element of dishwasher leaks.
E8	Failure of orientation of distributary valve.	Open circuit or break of distributary valve.
EC	Washing control system fail.	PCB or motor fail.
ED	Failure of communication between main PCB with display pcb.	Open circuit or break wiring for the communication.

### **WARNING:**

- › If overflow occurs, turn off the main water supply before calling a service.
- › If there is water in the base pan because of an overfill or small leak, the water should be removed before restarting the dishwasher.

### **SPARE PARTS AVAILABILITY**

The original spare parts for some specific components are available for a minimum of 7 or 10 years, based on the type of component, from the placing on the market of the last unit of the model.

For more info and to order spares, please contact Caple service or visit our website [www.caple.co.uk](http://www.caple.co.uk)

## TECHNICAL INFORMATION

---

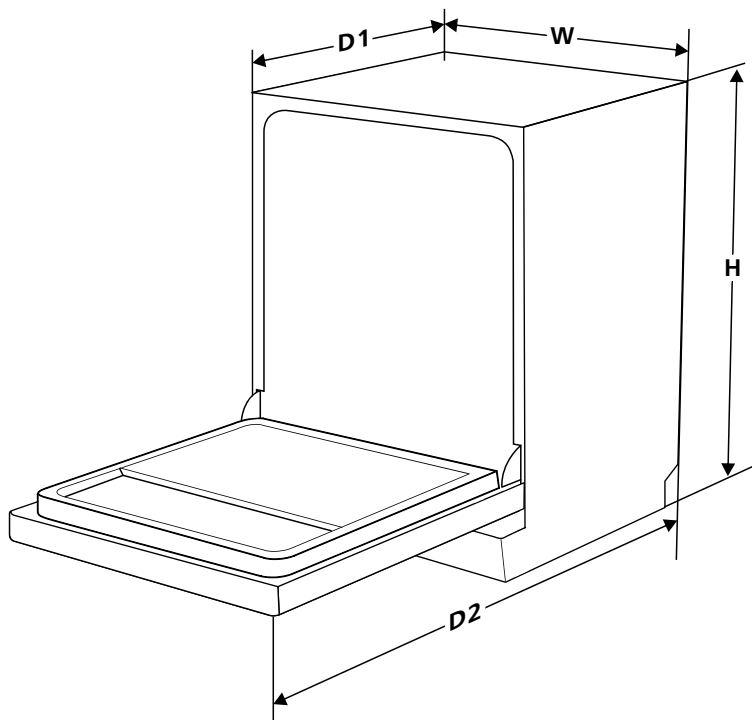

HEIGHT (H)	815mm
WIDTH (W)	598mm
DEPTH (D1)	550mm (with the door closed)
DEPTH (D2)	1150mm (with the door opened 90°)





Caple Service

Fourth Way

Avonmouth

Bristol

BS11 8DW

T: 0117 938 1900

E: [service@caple.co.uk](mailto:service@caple.co.uk)

[www.caple.co.uk](http://www.caple.co.uk)